

1  
2  
3  
4  
5  
6  
7  
8  
9  
10  
11  
12  
13  
14  
15  
16  
17  
18  
19  
20  
21  
22  
23  
24  
25  
26  
27  
28  
29  
30  
31  
32  
33  
34  
35  
36  
37  
38  
39  
40  
41  
42  
43  
44  
45  
46  
47  
48  
49  
50  
51  
52  
53  
54  
55  
56  
57  
58  
59  
60

A

B

C

D

E

F

Reuben's birthright was given to the sons of Joseph  
G 49:3; 1 CH 5:1

Reuben (1)  
Reubenites

Hanoch  
G 46:9; E 6:14  
Hanochites  
N 26:5

Pallu  
G 46:9; E 6:14  
(Phallu)  
Palluites  
N 26:5

Hezron  
G 46:9; E 6:14  
Hezronites  
N 26:6

Carmi  
G 46:9; E 6:14  
Carmites  
N 26:6

(\*1)

Joel  
1 Ch 5:4  
Shemaiah  
1 Ch 5:4

Gog  
1 Ch 5:4

Shimei  
1 Ch 5:4

Micah  
1 Ch 5:5

Reaiah  
1 Ch 5:5

Baal  
1 Ch 5:5

Beerah  
1 Ch 5:6

(\*1) Other descendants of Reuben

Eliab  
N 26:8

Nemuel  
N 26:9

Dathan  
N 26:9

Abiram  
N 26:9

Dan (5)  
Danites

Hushim  
G 46:23  
(Shuham)  
Shuhamites  
N 26:42

Naphtali (6)  
(Nephtalim)  
Naphtalites

Jahziel  
G 46:24; 1 Ch 7:13  
(Jahzeel)  
Jahzeelites  
N 26:48

Guni  
G 46:24; 1 Ch 7:13  
Gunites  
N 26:48

Jezer  
G 46:24; 1 Ch 7:13  
Jezerites  
N 26:49

Shillem  
G 46:24; 1 Ch 7:13  
(Shallum)  
Shillemites  
N 26:49

Gad (7)  
Gadites

Zephon  
G 46:16  
(Ziphion)  
Zephonites  
N 26:15

Haggi  
G 46:16  
Haggites  
N 26:15

Shuni  
G 46:16  
Shunites  
N 26:15

Ezbon  
G 46:16  
(Ozni)  
Oznites  
N 26:16

Eri  
G 46:16  
Erites  
N 26:16

Arodi  
G 46:16  
(Arod)  
Arodites  
N 26:17

G

H

I

J

K

L

M

N

Simeon (2)  
Simeonites

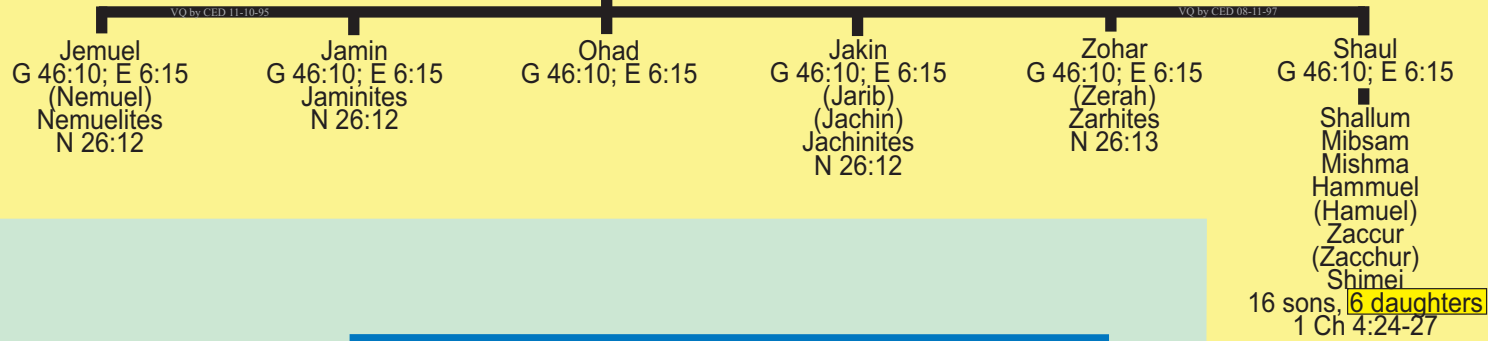

Northern Kingdom (Israel) composed of the following tribes:

Reuben    Simeon    Issachar  
Zebulun    Gad    Asher    Dan  
Naphtali    Ephraim    Manasseh

Southern Kingdom (Judah) composed of the following tribes:

Judah    Benjamin    Levi

Cain  
"farmer"  
Land of Nod  
East of Eden  
G 4:1, 16

Enoch  
G 4:17

Irada  
G 4:18

Mehujael  
G 4:18

Methushael  
G 4:18  
(Methusael)

Adah  
wife 1  
G 4:19  
"pleasure  
adornment"

Lamech  
G 4:18  
conqueror  
wild-man

Jabal  
G 4:20  
dwell in tents,  
have cattle

Jubal  
G 4:21  
harp and organ

Areli  
G 46:16  
Arelites  
N 26:17

**NOTE:** THIS IS A STUDY AID! Information is taken from the New International Version (NIV), King James (KJV), New American Standard (NAS) and New King James (NKJV) Versions, Treasury of Scripture Knowledge (TSK) and Strong's Concordance (STG). Using these you will find references and footnotes to the Septuagint and Vulgate. You may also find references to Masoretic Text, Samaritan Pentateuch or Syriac. What all of this means is

Kings of Israel

O P Q R S T U V

# Adam & Eve Family

*To Him Who Holds the Key*  
**Rev 3:7**

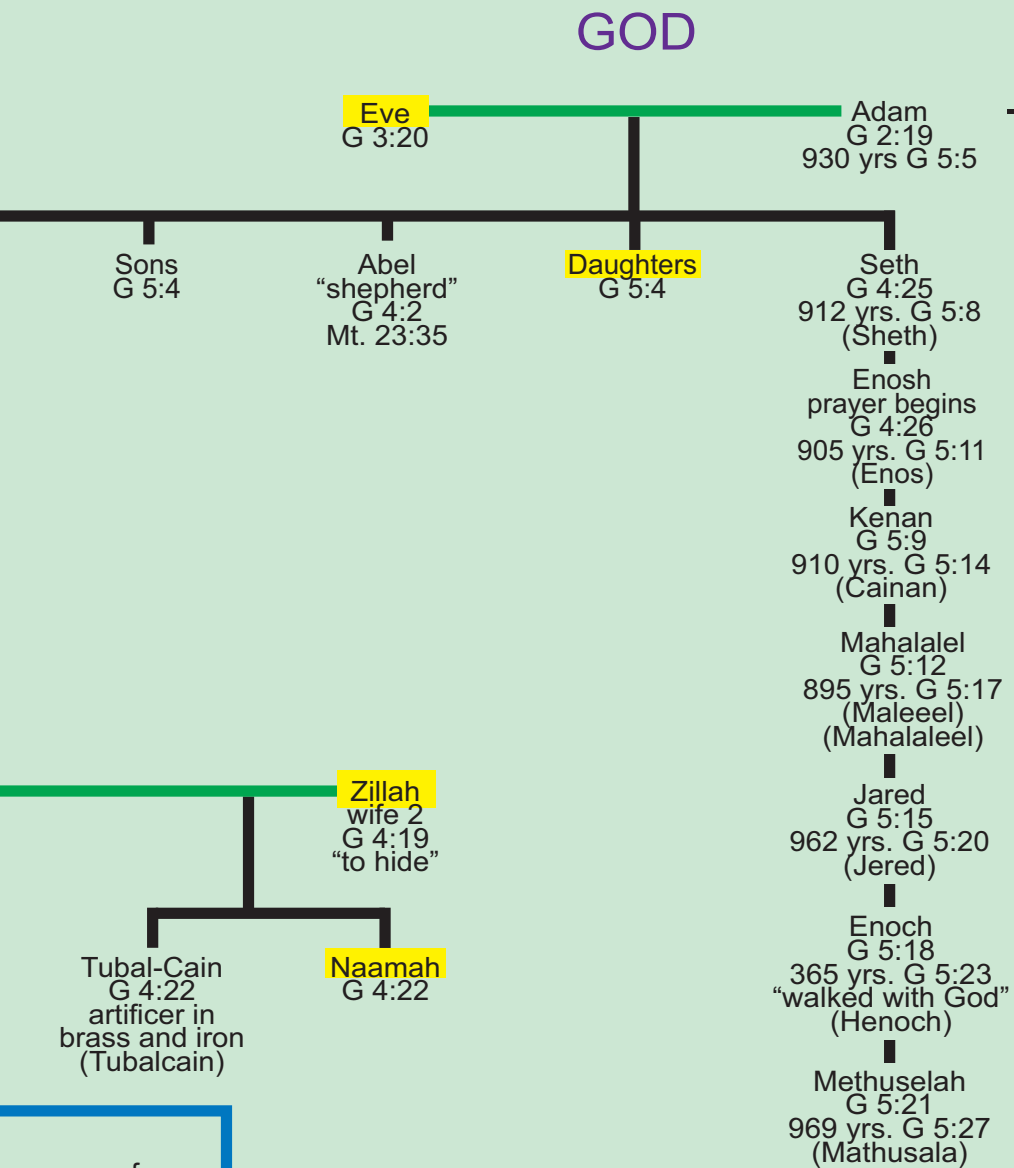

If you add the meanings of the names from Abram to Dinah you'd have the following statement of praise: "High father, father of nations, God hears the laughter of a rough man who deceives as (he) struggles with God. See a son who hears with praise, he has vindicated my struggle. A troop is coming that's happy. My reward and and honor may he add twice fruitful who will not forget the son of my right hand, at judgement." The words underlined are added to the original name meanings. To better illustrate this statement of praise look at the names and their meaning, in order.

- high father - Abram
- father of nations - Abraham
- God hears - Ishmael
- laughter - Isaac
- rough man - Esau
- deceives - Jacob
- (he) struggles with God - Israel
- see a son - Reuben
- who hears - Simeon
- attached - Levi
- praise - Judah
- he has vindicated - Dan
- my struggle - Naphtali
- a troop is coming - Gad
- happy - Asher
- reward - Issachar
- honor - Zebulum
- may he add - Joseph
- twice fruitful - Ephraim
- forget - Manasseh
- son of sorrow - Ben-oni (as named by mother)

W X Y Z AA AB AC AD

# Tree <sup>tm</sup>

## of David

Give the following  
 daughter of the  
 who hears, attached  
 happy whose  
 son of sorrow,  
 added to connect  
 at the names,

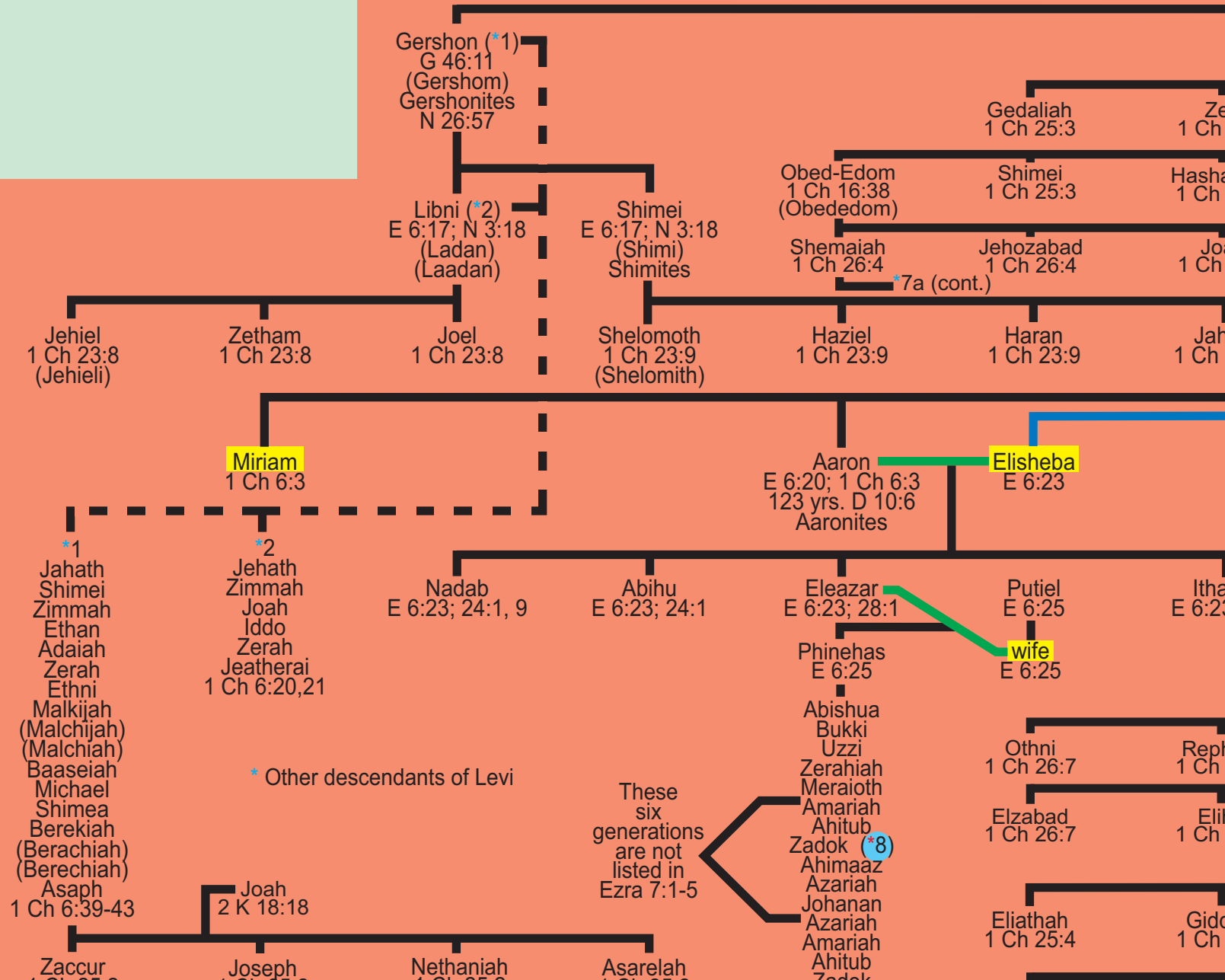

AE

AF

AG

AH

AI

AJ

AK

AL

A

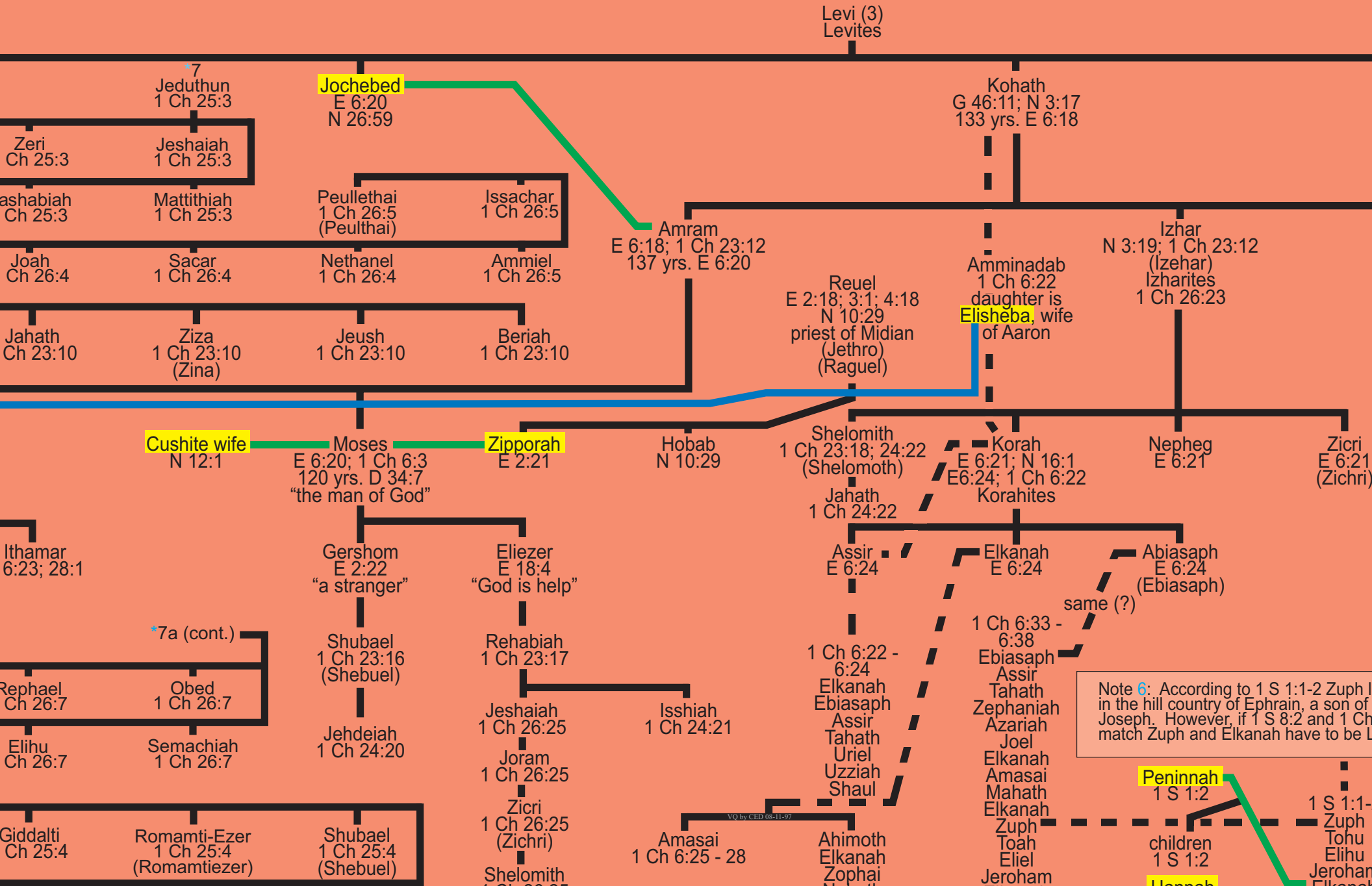

Note 6: According to 1 S 1:1-2 Zuph lived in the hill country of Ephraim, a son of Joseph. However, if 1 S 8:2 and 1 Ch 6:33-38 match Zuph and Elkanah have to be Levi.

VO by CED 08-11-97

Merari  
G 46:11; N 3:17  
Merarites  
N 26:57

Uzziel  
E 6:18; N 3:19  
(Aaron's uncle)  
Uzzielites  
1 Ch 26:23

Hebron  
N 3:19; 1 Ch 23:12  
Hebronites  
N 26:58

Jeriah  
1 Ch 23:19; 24:23  
(Jerijah)

Amariah  
1 Ch 23:19; 24:23

Jahaziel  
1 Ch 23:19; 24:23

Jekameam  
1 Ch 23:19; 24:23

Isshiah  
1 Ch 23:20; 24:23  
E 6:22  
(Jesiah)  
(Jesshiah)  
(Elzapan)

Micah  
1 Ch 23:20; 24:24  
E 6:22  
(Michah)  
(Mishael)

Sithri  
E 6:22  
(Zithri)

Zechariah  
1 Ch 24:24,25

Shamir  
1 Ch 24:24,25

Mahli  
E 6:19; 1 Ch 23:21  
(Mahali)  
Mahlites  
N 26:58

Mushi  
N 3:20; 1 Ch 23:21  
Mushites  
N 26:58

\*3 Libni  
Shimei  
Uzzah  
Shimea  
Haggiah  
Asaiah  
1 Ch 6:29,30

Eleazar  
1 Ch 23:21  
daughters  
no sons  
1 Ch 23:22

Kish  
1 Ch 23:21  
Jerahmeel  
1 Ch 24:29

Mahli  
1 Ch 23:23  
\*4

Eder  
1 Ch 24:30

Jerimoth  
1 Ch 24:30  
(Jeremoth)

\*4 Shemer  
(Shamer)  
Bani  
Amzi  
Hilkiah

up lived  
n of  
1 Ch 6:27-28  
be Levites.

1:1-2  
up  
phu  
ihu  
ham  
anah

59  
60  
61  
62  
63  
64  
65  
66  
67  
68  
69  
70  
71  
72  
73  
74  
75  
76  
77  
78  
79  
80  
81  
82  
83  
84  
85  
86  
87  
88  
89  
90  
91  
92  
93  
94  
95  
96  
97  
98  
99  
100  
101  
102  
103  
104  
105  
106  
107  
108  
109  
110  
111  
112  
113  
114  
115  
116  
117  
118  
119  
120  
121  
122  
123  
124  
125

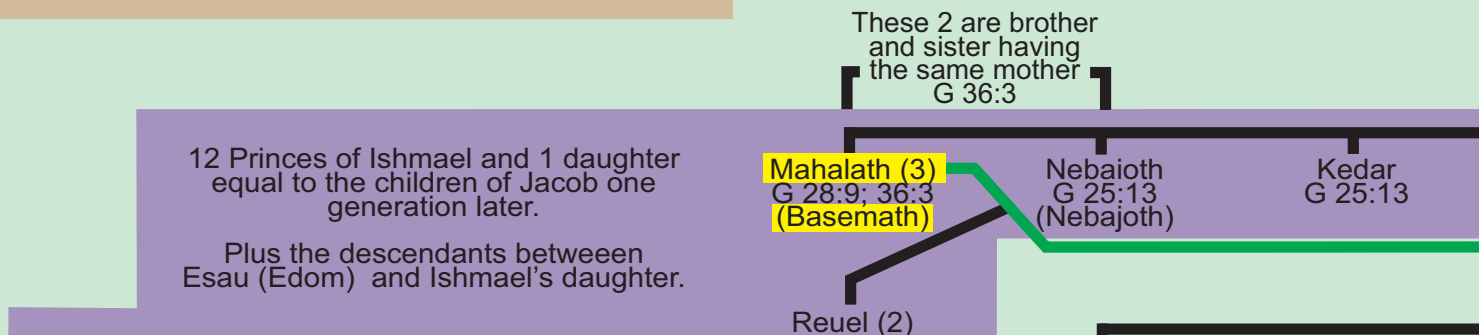
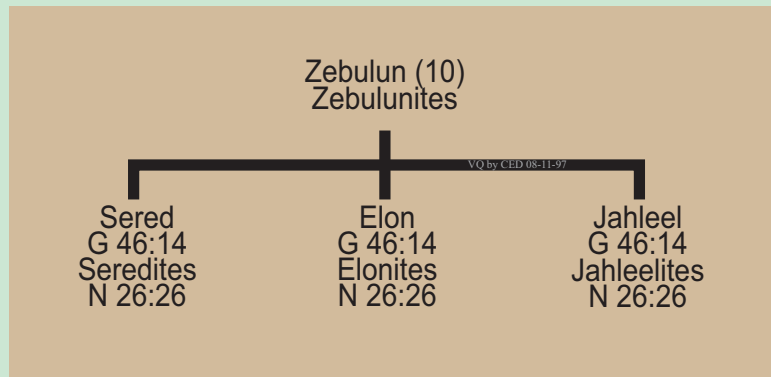
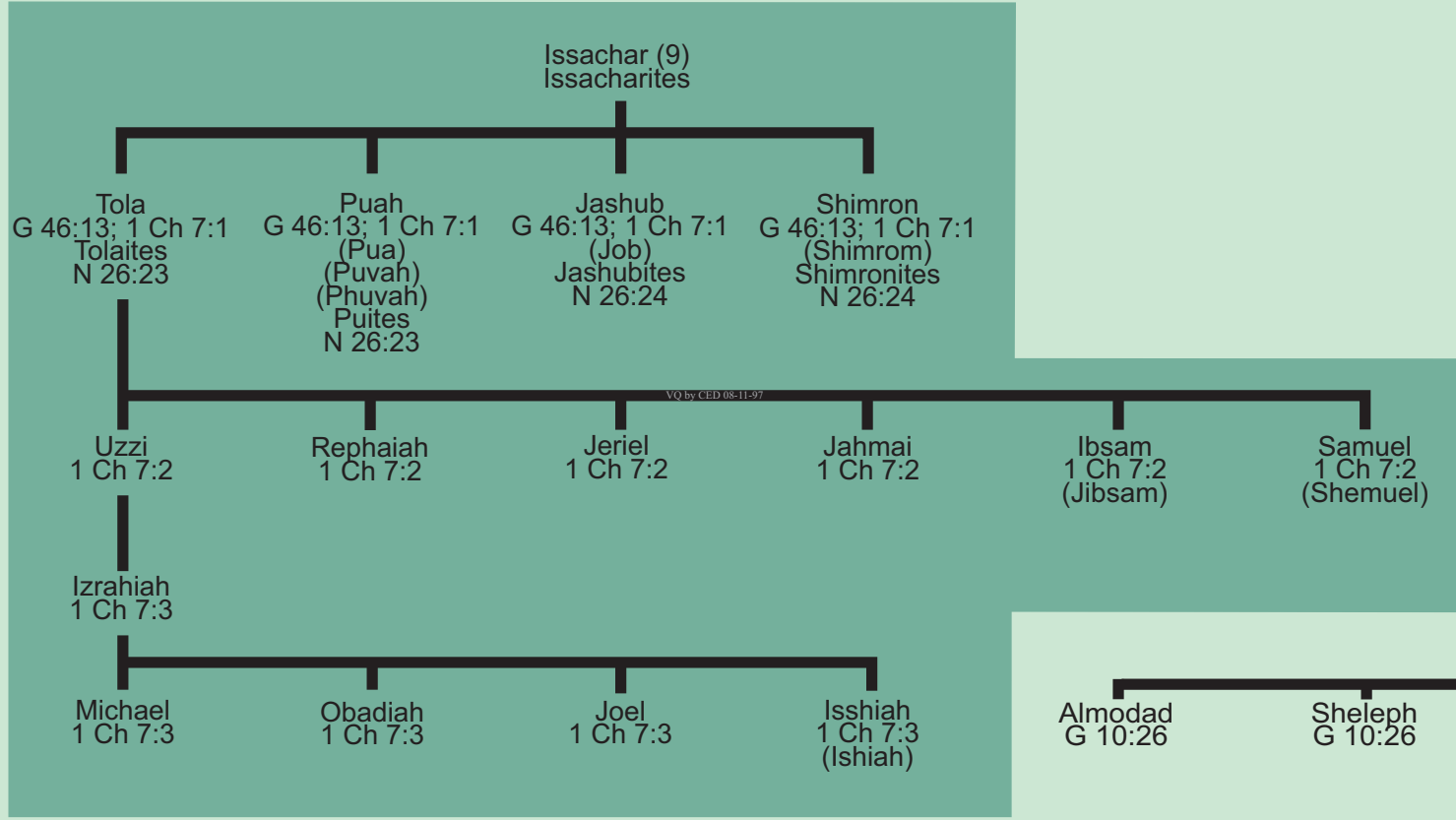

Septuagint and Vulgate. You may also find references to Masoretic Text, Samaritan Pentateuch or Syriac. What all of this means is that the exact genealogy of the Bible may never be known. This chart illustrates the various blood-lines as recorded in the Bible and makes notes via dashed lines or astericks where there are differences between different books of the Bible.

### GUIDE TO COLORS AND LINES

- 1 Women are highlighted in yellow
- 2 Green lines are male/female partners
- 3 Black lines are children of the above union or descendant
- 4 Blue lines show same person under two different lines
- 5 Notes are numbers; if colored it is located in another tribe area
- 6 Dashed lines represent two different presentations of the same line from two different Bible verses and presents a conflict.

Kings of Israel				
1	Jeroboam	1 Ki 14:20	22 years	After nine y
2	Nadab	1 Ki 15:25	2 years	reign by Ki
3	Baasha	1 Ki 15:33	24 years	Israel was
4	Elah	1 Ki 16:8	2 years	captivity by
5	Zimri	1 Ki 16:15	1 week	2 King
6	Omri	1 Ki 16:23	12 years	
7	Ahab	1 Ki 16:29	22 years	Please rem
8	Ahaziah	1 Ki 22:51	2 years	Israel here
9	Jehoram	2 Ki 3:1	12 years	the Norther
10	Jehu	2 Ki 10:36	28 years	the ten-tribe
11	Jehoahaz	2 Ki 13:1	17 years	
12	Joash	2 Ki 13:10	16 years	From Biblio
13	Jeroboam II	2 Ki 14:23	41 years	have a reco
14	Zachariah	2 Ki 15:8	6 months	existing for
15	Shallum	2 Ki 15:13	1 month	241 years,
16	Menahem	2 Ki 15:17	10 years	and 1 week
17	Pekahiah	2 Ki 15:23	2 years	split with Ju
18	Pekah	2 Ki 15: 27	20 years	Southern K
19	Hoshea	2 Ki 17:1	9 years	

Hazarmaveth G 10:26    Jerah G 10:26    Hadoram G 10:27    Uzal G 10:27    Diklah G 10:27    Obal G 10:28; 1 Ch 1:32 (Ebal)    Abimael G 10:28    Sheba G 10:28

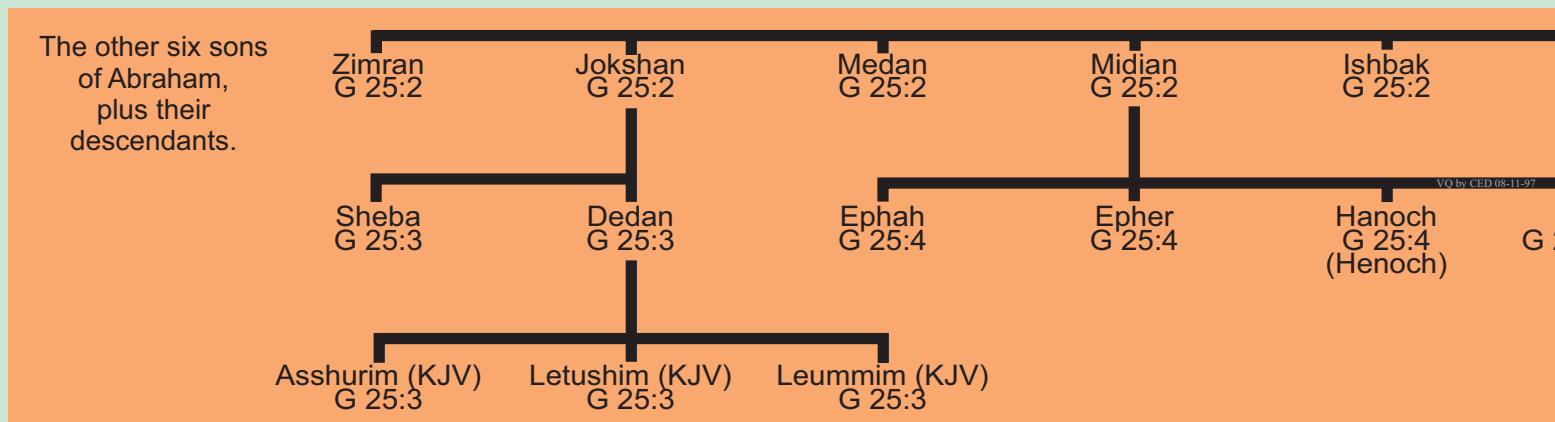

Adbeel G 25:13    Mibsam G 25:13    Mishma G 25:14    Dumah G 25:14    Massa G 25:14    Hadad G 25:15 (Hadar)    Tema G 25:15    Jetur G 25:15

Seir G 36:20; 1 Ch 1:38

Elon G 36:2  
Hethite, Hittite



the years of  
y King Hoshea  
was carried into  
y by Assyria  
Kings 17:6, 23

remember that  
ere represents  
thern Kingdom,  
-tribed nation.

biblical text we  
record of Israel  
g for a total of  
ars, 7 months  
week after the  
th Judah, the  
rn Kingdom.

forget - Manasseh  
son of sorrow - Ben-oni (as named by mother)  
son of my right hand - Benjamin (as named by father)  
judgement - Dinah

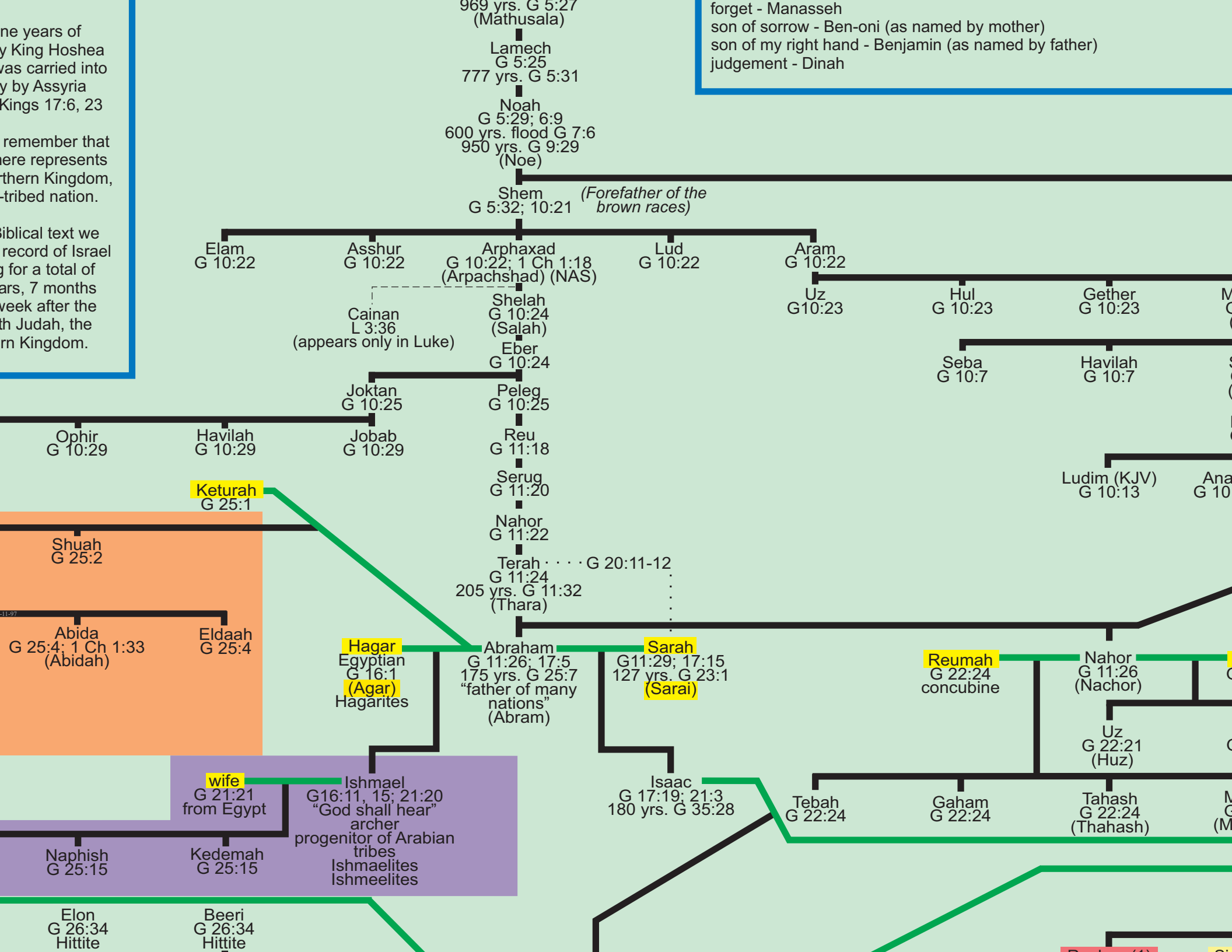

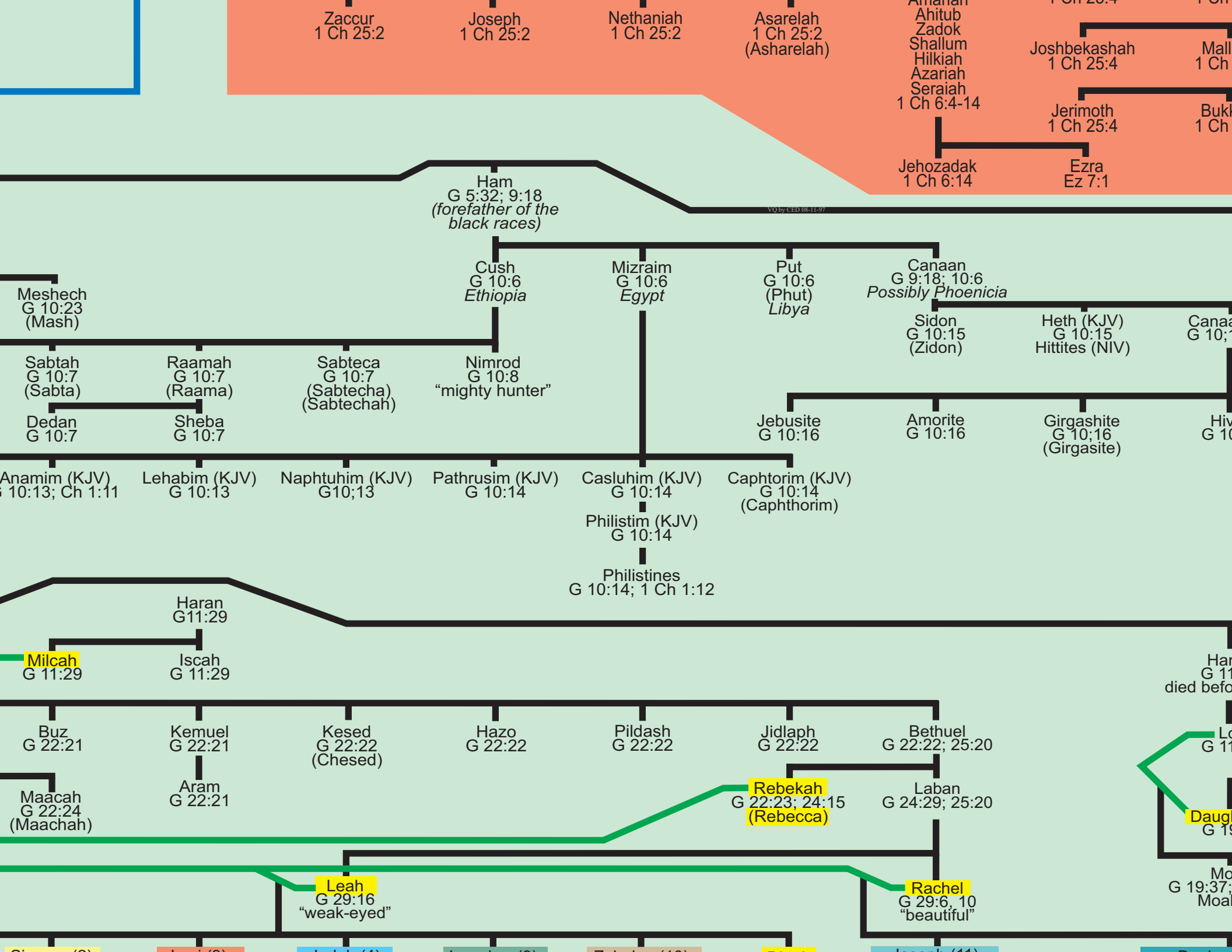

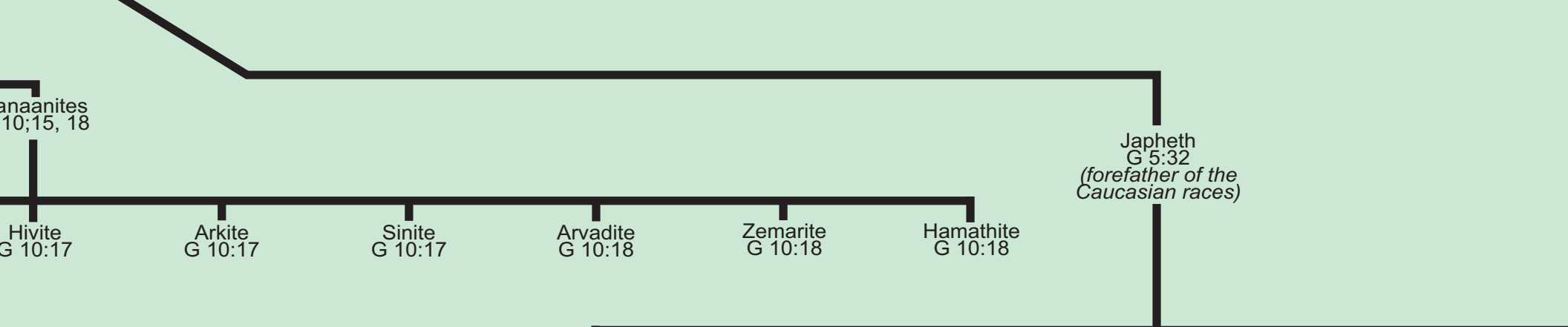
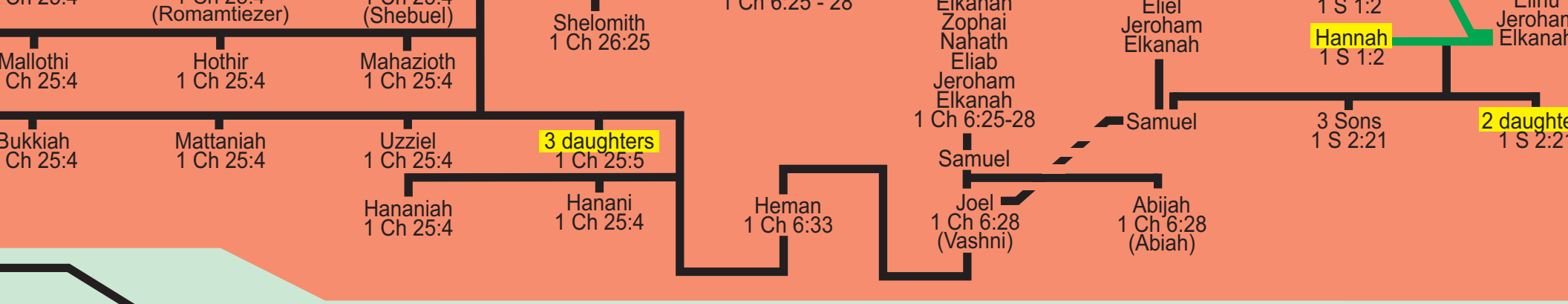

\* From these seven sons of Japheth are descended the Gentile nations.  
 \*\* Gentile means - heathen, non-Israelite, foreigner

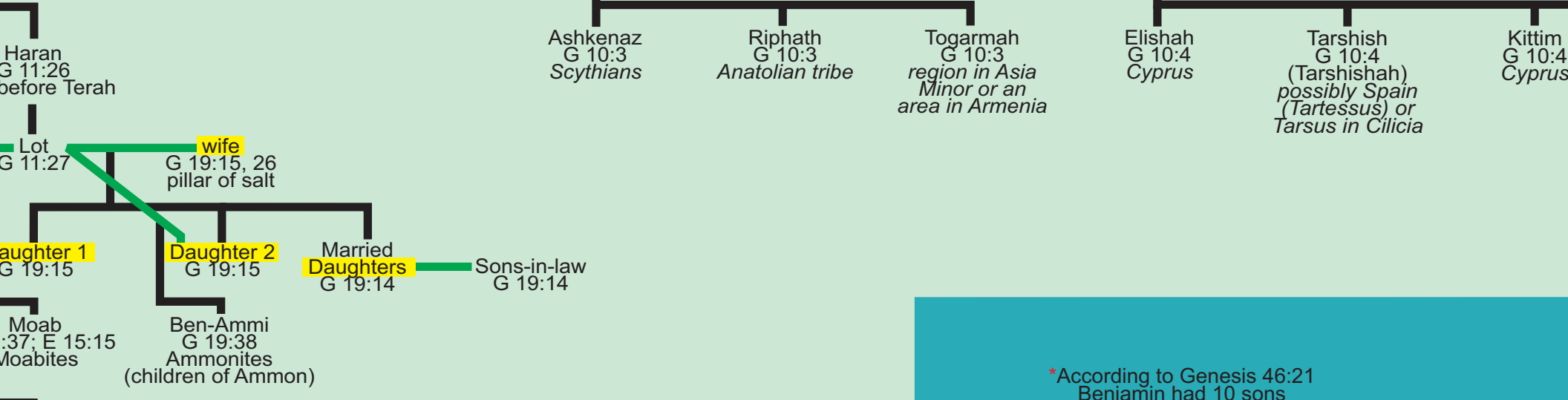

\*According to Genesis 46:21 Benjamin had 10 sons

pham  
anah

\* 5 Jaaziah  
1 Ch 24:27

Beno  
1 Ch 24:27

Shoham  
1 Ch 24:27

Zaccur  
1 Ch 24:27

Ibri  
1 Ch 24:27

Dani  
Amzi  
Hilkiah  
Amaziah  
Hashabiah  
Malluch  
Abdi  
Kishi  
(Kushaiah)  
Ethan  
1 Ch 6:44-47

ughters  
2:21

ech (6)  
10:2  
Minor,  
bly an  
an tribe

Tiras (7)  
G 10:2  
Thracians

tim  
10:4  
prus

Rodanim (NIV)  
G 10:4  
(Dodanim) (KJV)  
Rhodes

### Census of Israel

Tribe	1st Census 2 years after leaving Egypt	2nd Census On the plains of Moab by the Jordan across from Jerico.
Reuben	46,500	43,730
Simeon	59,300	22,200
Gad	45,650	40,500
Judah	74,600	76,500
Issachar	54,400	64,300
Zebulun	57,400	60,500
Joseph		
{ Ephraim	40,500	32,500
{ Manasseh	32,200	52,700
Benjamin	35,400	45,600
Dan	62,700	64,400
Asher	41,500	53,400
Naphtali	53,400	45,400
Levi	In Charge of the tabernacle and not counted N 1:20-50                      N 26:5-50	

Benjamin (12)  
(Ben-Oni)  
Benjamites

Smallest tribe  
of Israel  
1 S 9:21

\*According to 1 Ch 7:6  
Benjamin had 3 sons

\*According to 1 Ch 8:1,2  
Benjamin had 5 sons

59  
60  
61  
62  
63  
64  
65  
66  
67  
68  
69  
70  
71  
72  
73  
74  
75  
76  
77  
78  
79  
80  
81  
82  
83  
84  
85  
86  
87  
88  
89  
90  
91  
92  
93  
94  
95  
96  
97  
98  
99  
100  
101  
102  
103  
104  
105  
106  
107  
108  
109  
110  
111  
112  
113  
114  
115  
116  
117  
118  
119  
120  
121  
122  
123  
124  
125

124  
125  
126  
127  
128  
129  
130  
131  
132  
133  
134  
135  
136  
137  
138  
139  
140  
141  
142  
143  
144  
145  
146  
147  
148  
149  
150  
151  
152  
153  
154  
155  
156  
157  
158  
159  
160  
161  
162  
163  
164  
165  
166  
167  
168  
169  
170  
171  
172  
173  
174  
175  
176  
177  
178  
179  
180  
181  
182  
183  
184  
185  
186  
187  
188  
189  
190  
191

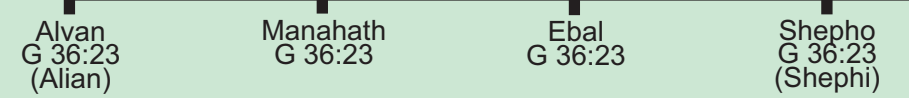
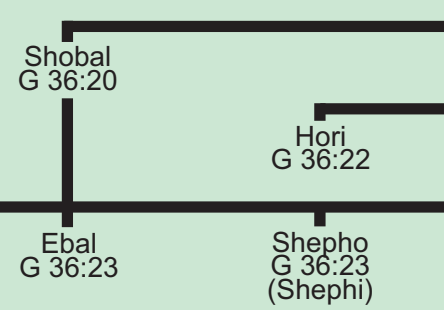
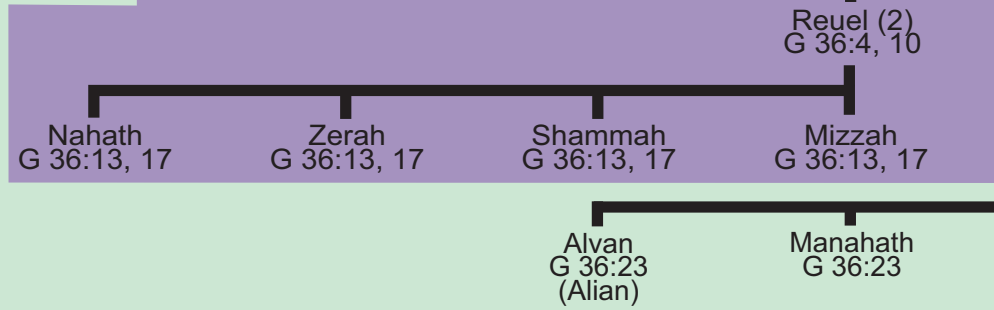

Asher (8)  
Asherites

\*Other descendants of Asher (\*1)

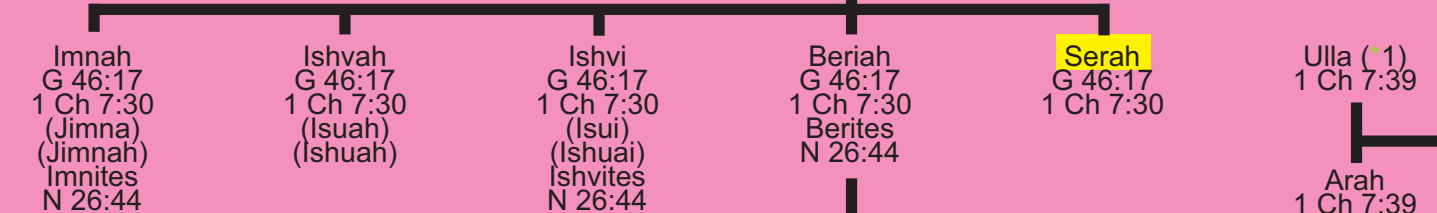

Heber  
G 46:17  
Heberites N 26:45

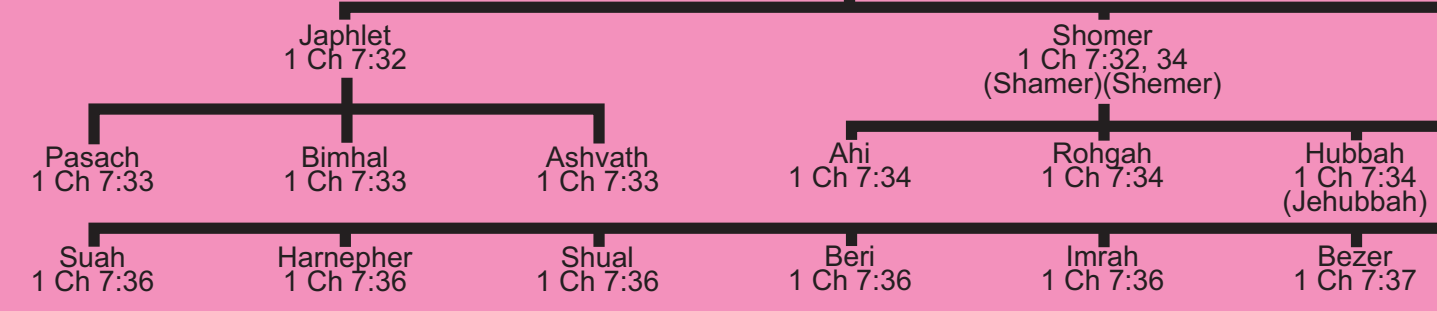

Tribe ho  
given to  
after tak  
by Jaco



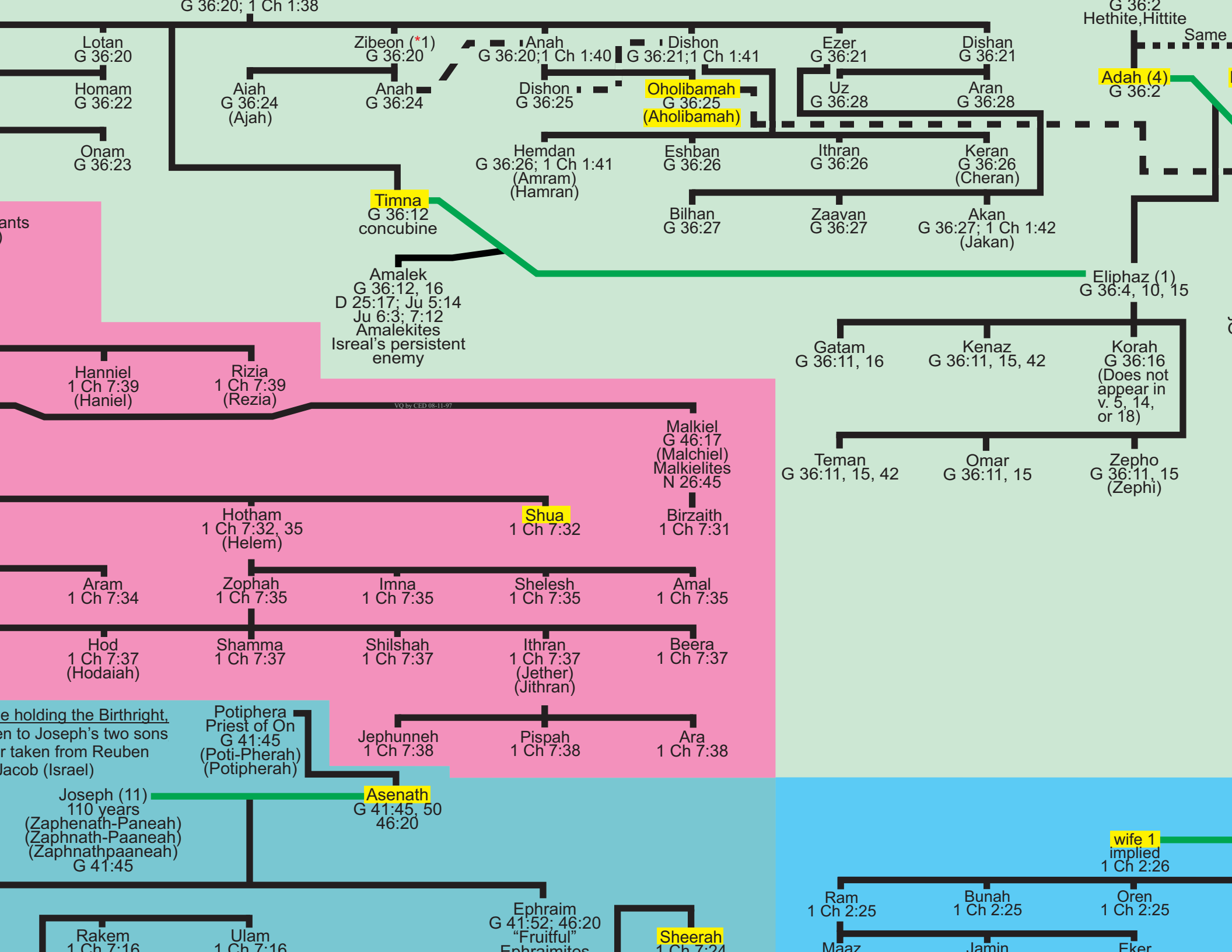

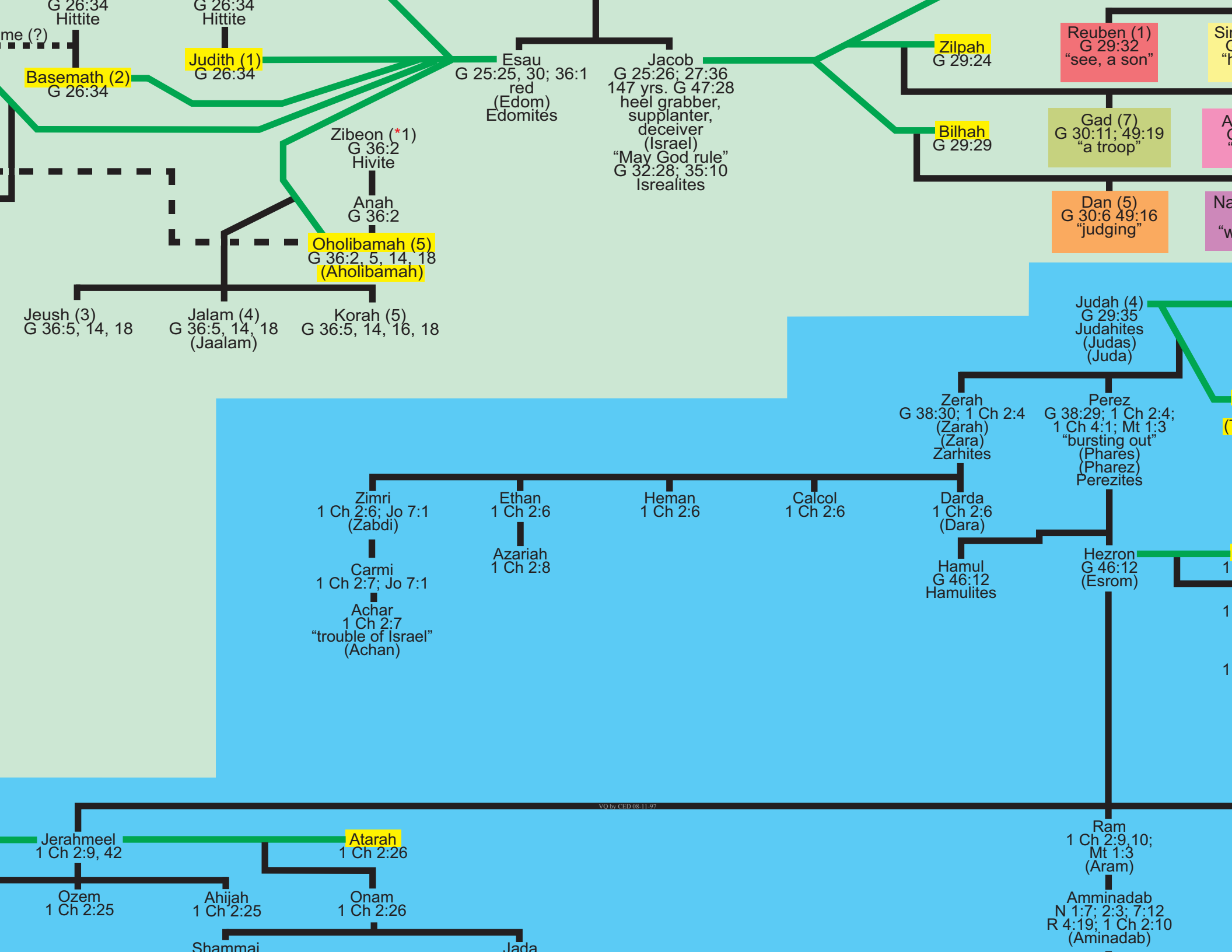

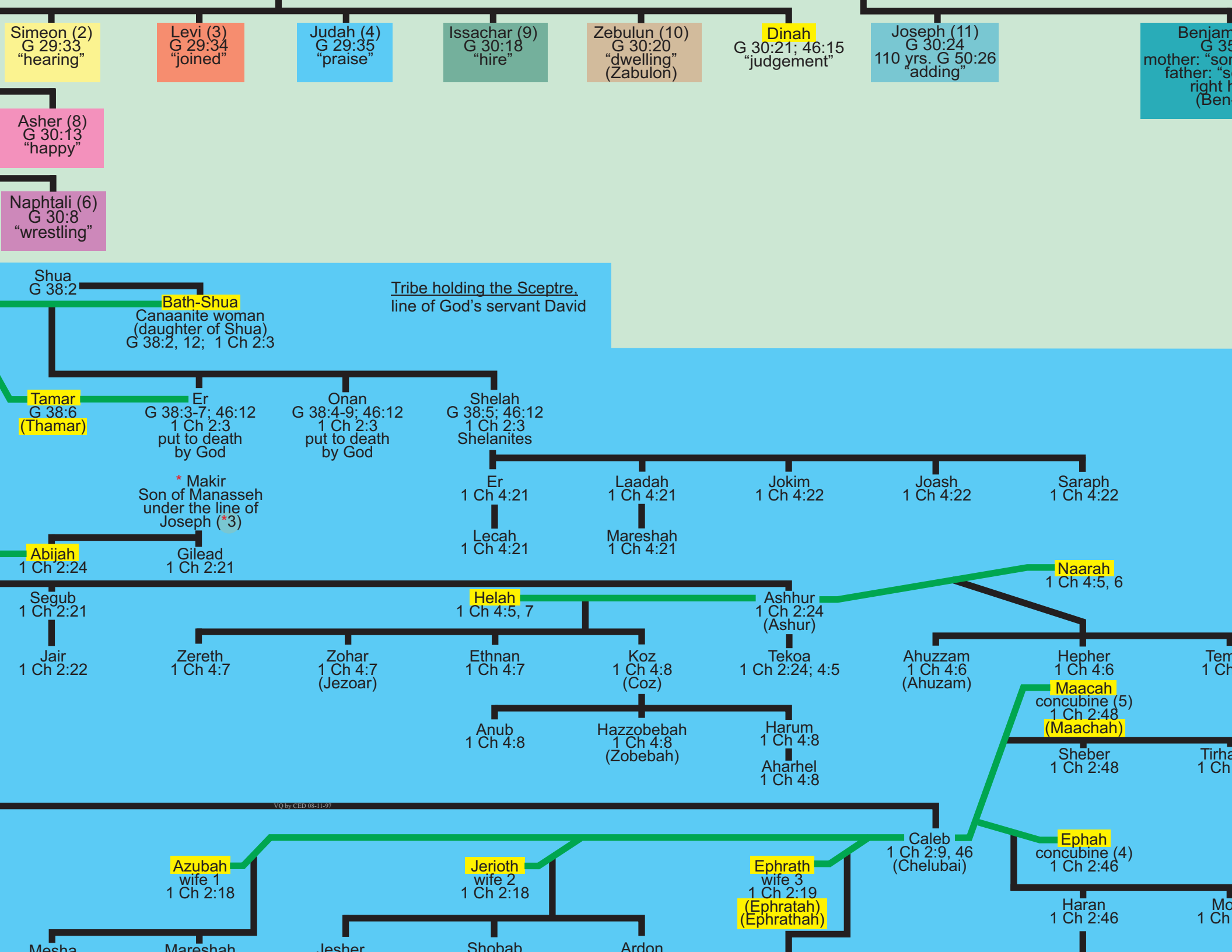



Benjamin (12)  
 G 35:18  
 "son of sorrow"  
 r: "son of my  
 right hand"  
 Ben-oni)

Benjamin had 10 sons

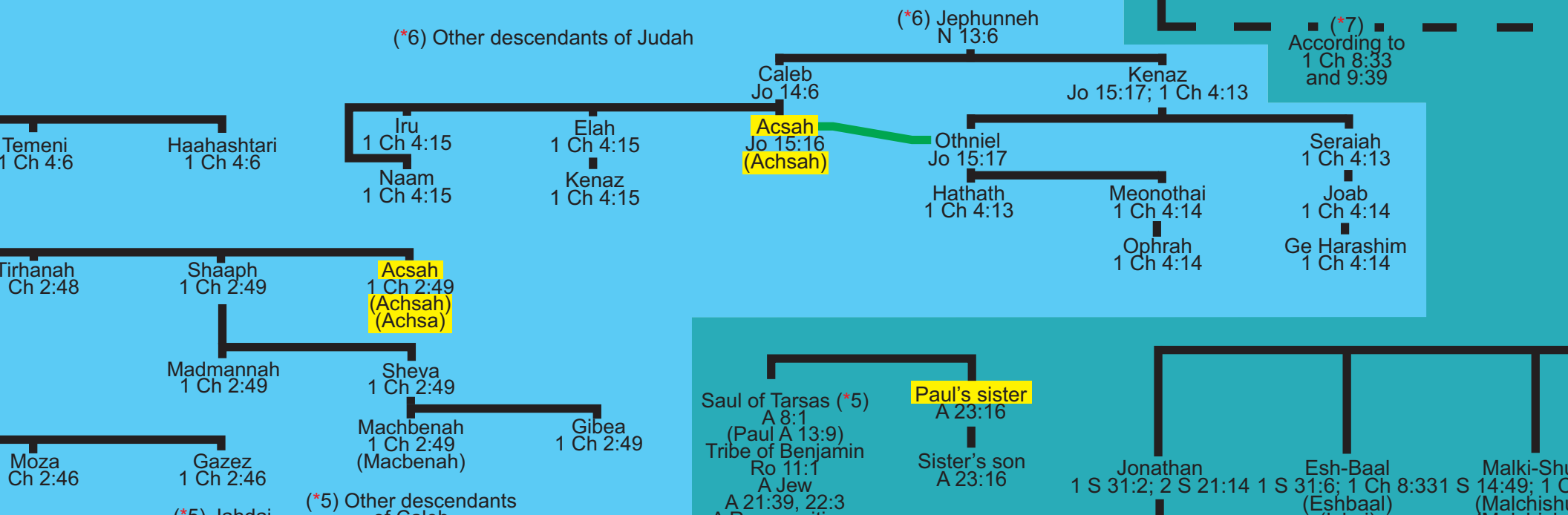
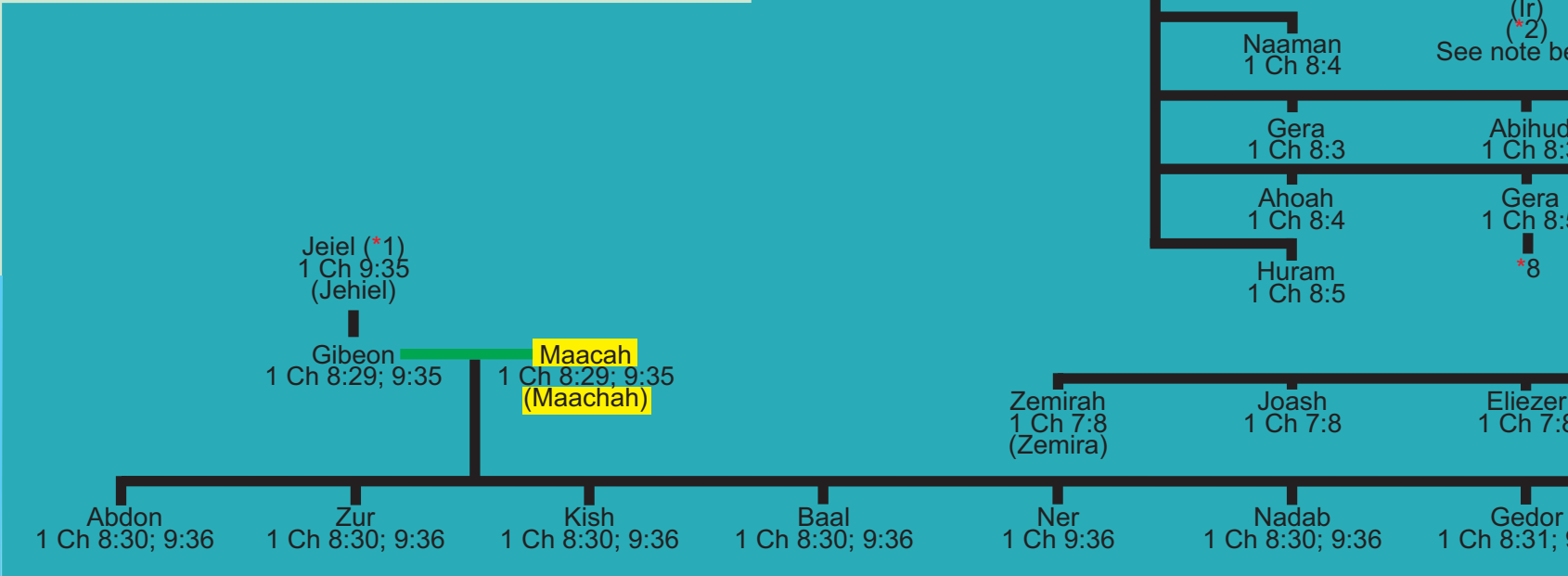
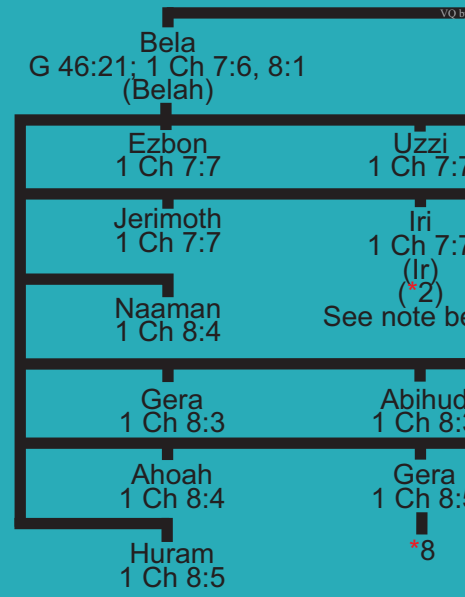

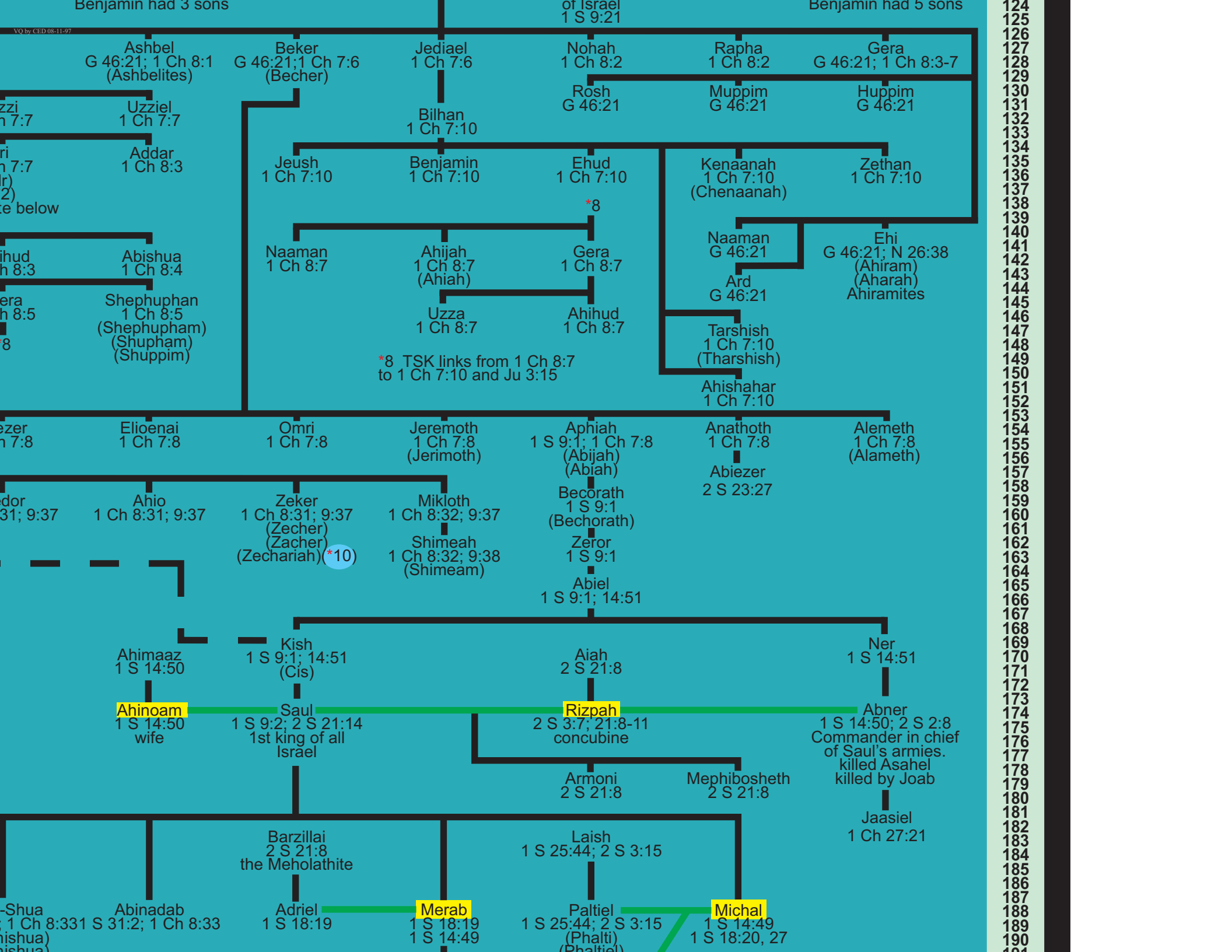

189  
190  
191  
192  
193  
194  
195  
196  
197  
198  
199  
200  
201  
202  
203  
204  
205  
206  
207  
208  
209  
210  
211  
212  
213  
214  
215  
216  
217  
218  
219  
220  
221  
222  
223  
224  
225  
226  
227  
228  
229  
230  
231  
232  
233  
234  
235  
236  
237  
238  
239  
240  
241  
242  
243  
244  
245  
246  
247  
248  
249  
250  
251  
252  
253  
254  
255  
256

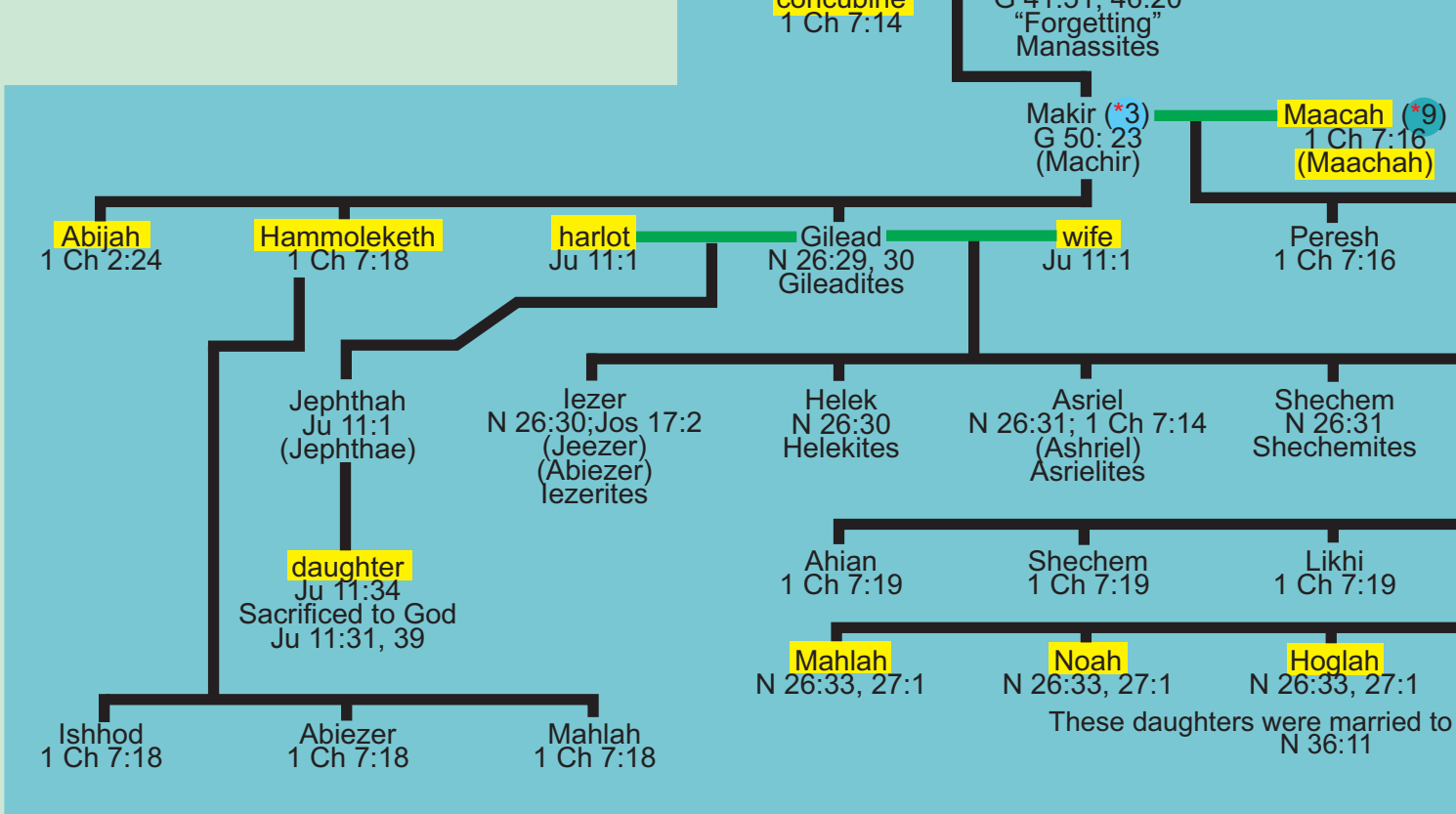

224	A	Ahiahud - AQ144	Ardon - AA191	Beker - AO127	Daniel - M234	Elishama - K210	Gera - AM1
225		Ahijah - AP140	Areli - G50	Beker - J195	Dara - U161	Elishama - Q226	Gera - AQ1
226	Aaron - AC32	Ahijah - P187	Armoni - AQ179	Bela - AL127	Darda - U159	Elishama - X234	Gera - AS12
227	Abdi - AR65	Ahimaaz - AA240	Arnan - P279	Belah - AL129	Dathan - C21	Elisheba - AD32	Gershon - A
228	Abdon - AG272	Ahimaaz - AC54	Arod - F52	Ben-Abinadab - Y240	David - V216	Elisheba - W187	Gershon - A
229	Abdon - AG159	Ahimaaz - AN170	Arodi - F50	Ben-Ammi - AF120	Dedan - K103	Elishua - X232	Gershon - A
230	Abel - P23	Ahimoath - AJ57	Arpachshad - R78	Ben-Oni - AE131	Dedan - W88	Eliud - L289	Gesham - A
231	Abi - W299	Ahinoam - AN174	Arphaxad - R76	Ben-Oni - AP121	Delaiah - S296	Elkanah - AJ48	Geshan - AF
232	Abia - V253	Ahinoam - L229	Asa - V255	Benjamin - AE126	Diklah - K89	Elkanah - AJ58	Gether - V7
233	Abiah - AK72	Ahio - AD268	Asahel - AA220	Benjamin - AP120	Dinah - AB126	Elkanah - AJ64	Gibeab - AH
234	Abiah - AQ157	Ahio - AN159	Asaiah - AN56	Benjamin - AP135	Dishan - M127	Elkanah - AK39	Gibeon - AF
235	Abiasaph - AL39	Ahio - U220	Asaph - Y55	Beno - AN66	Dishon - J130	Elkanah - AK52	Giddalti - A
236	Abida - O103	Ahiram - AS142	Asarelah - AB60	Berachiah - Y53	Dishon - K127	Elkanah - AK55	Gilead - D1
237	Abidah - O105	Ahishahar - AR151	Asenath - I180	Beraiah - AI285	Dodanim - AO106	Elkanah - AK61	Gilead - X1
238	Abiel - AQ165	Ahitub - AC52	Asharelah - AB62	Berechiah - R274	Dumah - J119	Elkanah - AM60	GOD - Q13
239	Abiezer - AR157	Ahitub - AC59	Ashbel - AN127	Berechiah - Y54		Elmadam - U285	Gog - F14
240	Abiezer - B220	Ahlai - Q208	Asher - D140	Bered - I202		Elmodam - U287	Gomer - AF
241	Abiezer - C209	Ahoah - AL145	Asher - W132	Bered - J197		Elnathan - M253	Guni - B35
242	Abigail - AB216	Aholibamah - K132	Ashhur - AB166	Berekiah - R272	Ebal - E134	Elon - B106	
243	Abigail - M225	Aholibamah - Q143	Ashkenaz - AH104	Berekiah - Y52	Ebal - L91	Elon - N123	H
244	Abihail - AJ228	Ahumai - AC212	Ashriel - E208	Beri - D169	Eber - AD262	Elon - O123	
245	Abihail - Q194	Ahuzam - AC172	Ashur - AB168	Beriah - AG262	Eber - AE272	Elpaal - AI250	Haahashtari
246	Abihail - R221	Ahuzzam - AC170	Ashvath - C165	Beriah - AH25	Eber - R83	Elpalet - Y234	Hadad - L1
247	Abihu - AB39	Aiah - AQ170	Asriel - E206	Beriah - D145	Ebiasaph - AJ49	Elpelet - Y232	Hadar - L12
248	Abihud - AM142	Aiah - H130	Asshur - Q76	Beriah - K195	Ebiasaph - AK46	Elzabad - AD51	Hadassah -
249	Abijah - A199	Ajah - H132	Asshurim - J110	Beth Gader - AF203	Ebiasaph - AL41	Elzaphan - AN44	Hadoram -
250	Abijah - AK70	Akan - M139	Assir - AJ39	Bethgader - AF205	Eder - AI268	Enoch - N30	Hagar - Q1
251	Abijah - AQ156	Akim - L286	Assir - AJ50	Bethlehem - AE211	Eder - AR52	Enoch - R50	Haggi - B5

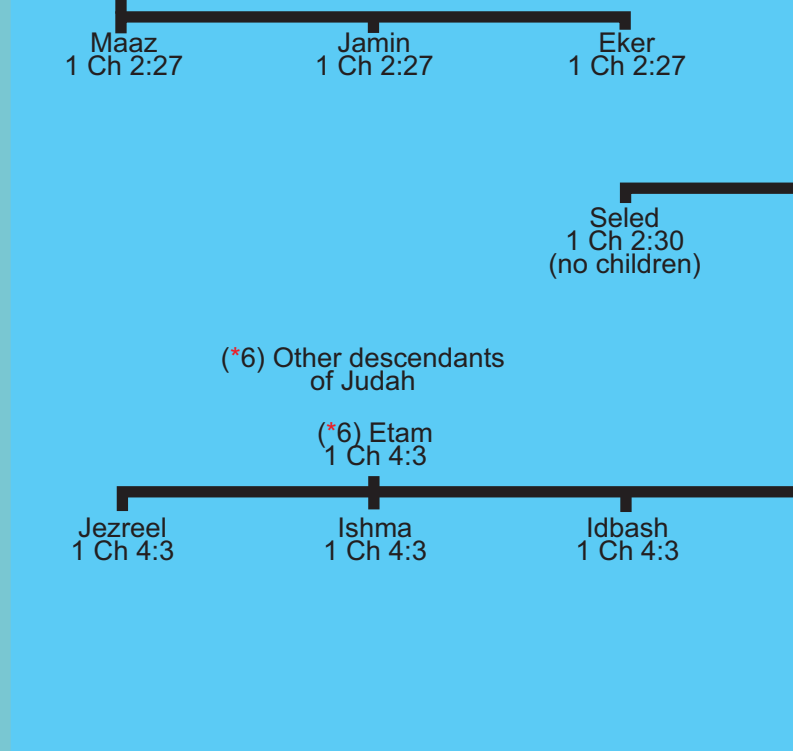
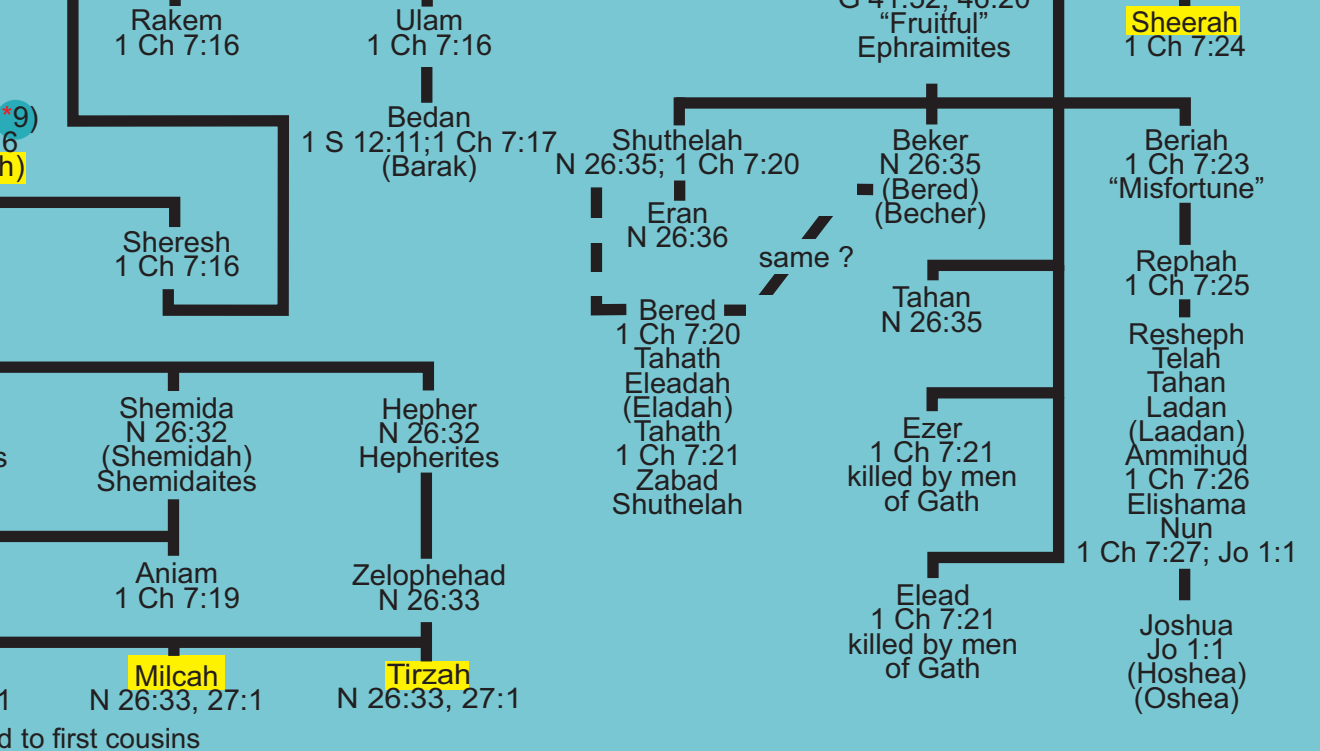

AM145	Helez - Q220	Ishvi - AN191	Jehiel - AH149	Jibsam - E80
AQ140	Heli - K304	Ishvi - C145	Jehiel - Y25	Jidlaph - AB110
AS127	Heman - AI70	Ispah - AI274	Jehieli - Y27	Jimna - A148
AM - AA12	Heman - S159	Israel - S134	Jehoadah - AN211	Jimnah - A149
AM - AG39	Hemdan - J134	Issachar - AH16	Jehoaddah - AN209	Jithra - AC219
AM - AA9	Henoch - N105	Issachar - C62	Jehoaddan - W279	Jithran - J172
AM - AH195	Henoch - R54	Issachar - Z126	Jehoaddin - W277	Jizliah - AI292
AM - AH197	Hepher - AD170	Isshiah - AI49	Jehoahaz - N252	Joab - AL173
AM - V79	Hepher - H206	Isshiah - AN39	Jehoahaz - V300	Joab - Z220
AM - AH186	Hepzibah - W302	Isshiah - D89	Jehoash - V281	Joah - AE21
AM - AH152	Heth - AD81	Isuah - B148	Jehoiachin - L256	Joah - Z40
AM - AE57	Hezeki - AF291	Isui - C148	Jehoiadia - X269	Joah - Z55
AM - D199	Hezekiah - R294	Ithamar - AE39	Jehoiakim - L250	Joanan - K246
AM - X163	Hezekiah - V302	Ithra - AC218	Jehonadab - AG226	Joanna - K248
AM - Q13	Hezron - D7	Ithran - J169	Jehoram - V265	Joannas - K249
AM - F14	Hezron - V163	Ithran - L134	Jehoshabeath - W271	Joash - AC158
AM - AH95	Hilkiah - AC62	Ithream - R234	Jehoshaphat - V260	Joash - AL154
AM - B35	Hilkiah - AR60	Izhear - AL21	Jehosheba - W269	Joash - V277
H	Hizki - AF289	Izhar - AL18	Jehozabad - AD21	Joatham - V295
	Hizkiah - R292	Izliah - AI289	Jehozadak - AC70	Job - C70
	Hobab - AI32	Izrahiah - A84	Jehu - Q218	Jobab - AD257
	Hod - G169	J	Jehubbah - F167	Jobab - AJ289
	Hodaiah - G171		Jeiel - AH147	Jobab - Q89
	Hodaviah - N297		Jekameam - AQ32	Jochebed - AG9
	Hodesh - AE252		Jekamiah - P225	Joda - K251
	Hoglah - F217	Jaalam - P148	Jekamiah - P261	Joel - AA25
	Homam - G130	Jaareshiah - AQ201	Jemuel - G7	Joel - AJ70
	Hori - F130	Jaasiel - AS181	Jephtae - B208	Joel - AK51
		Jaaziah - AN62		

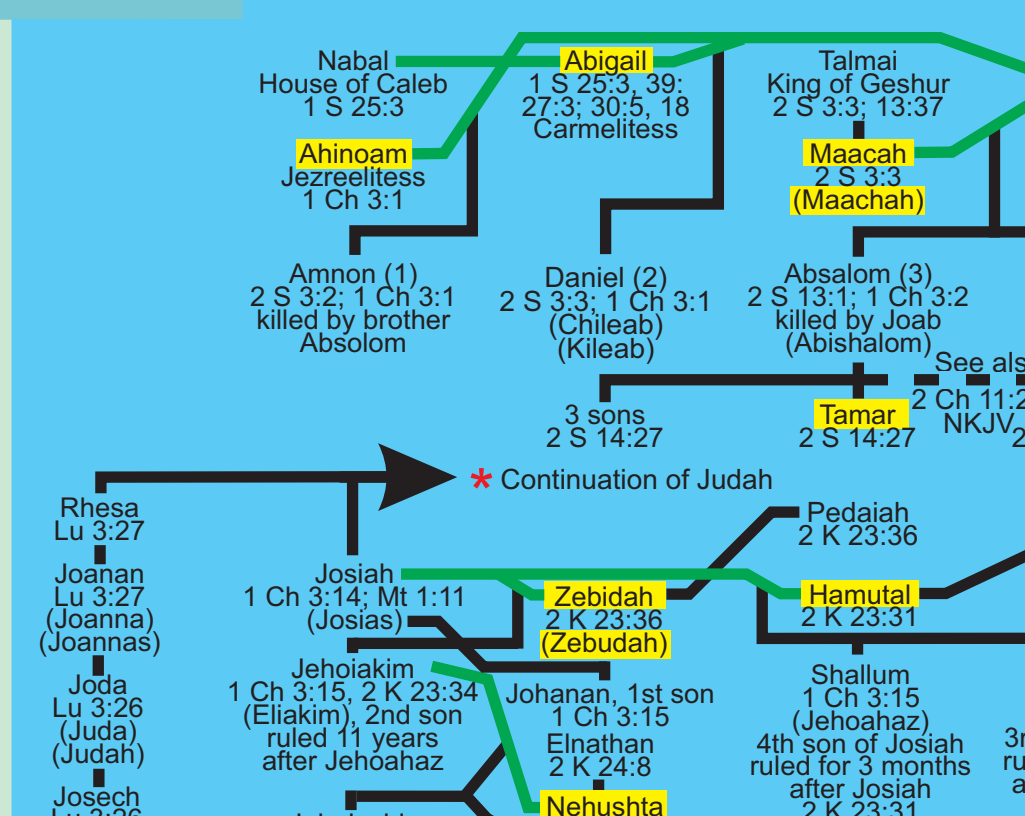

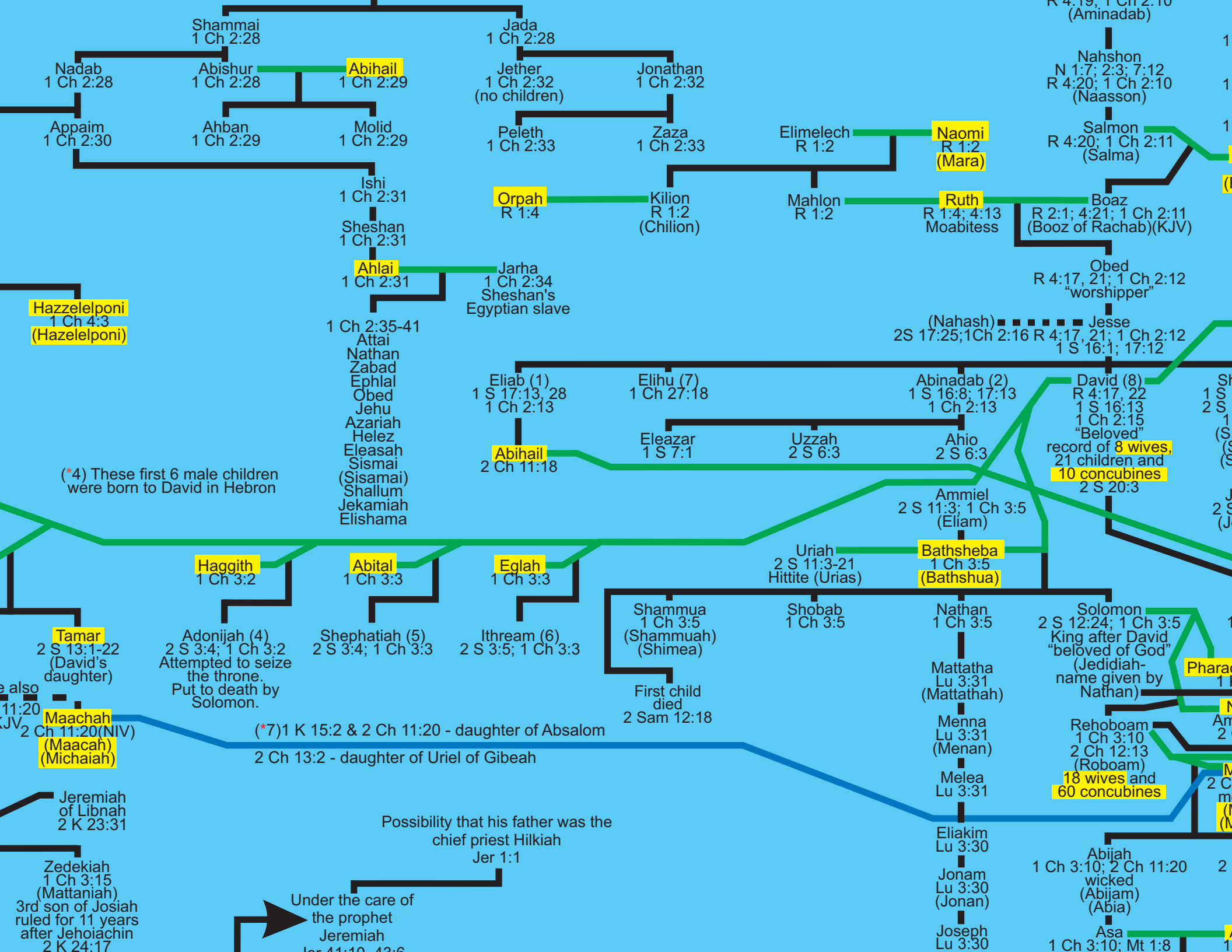

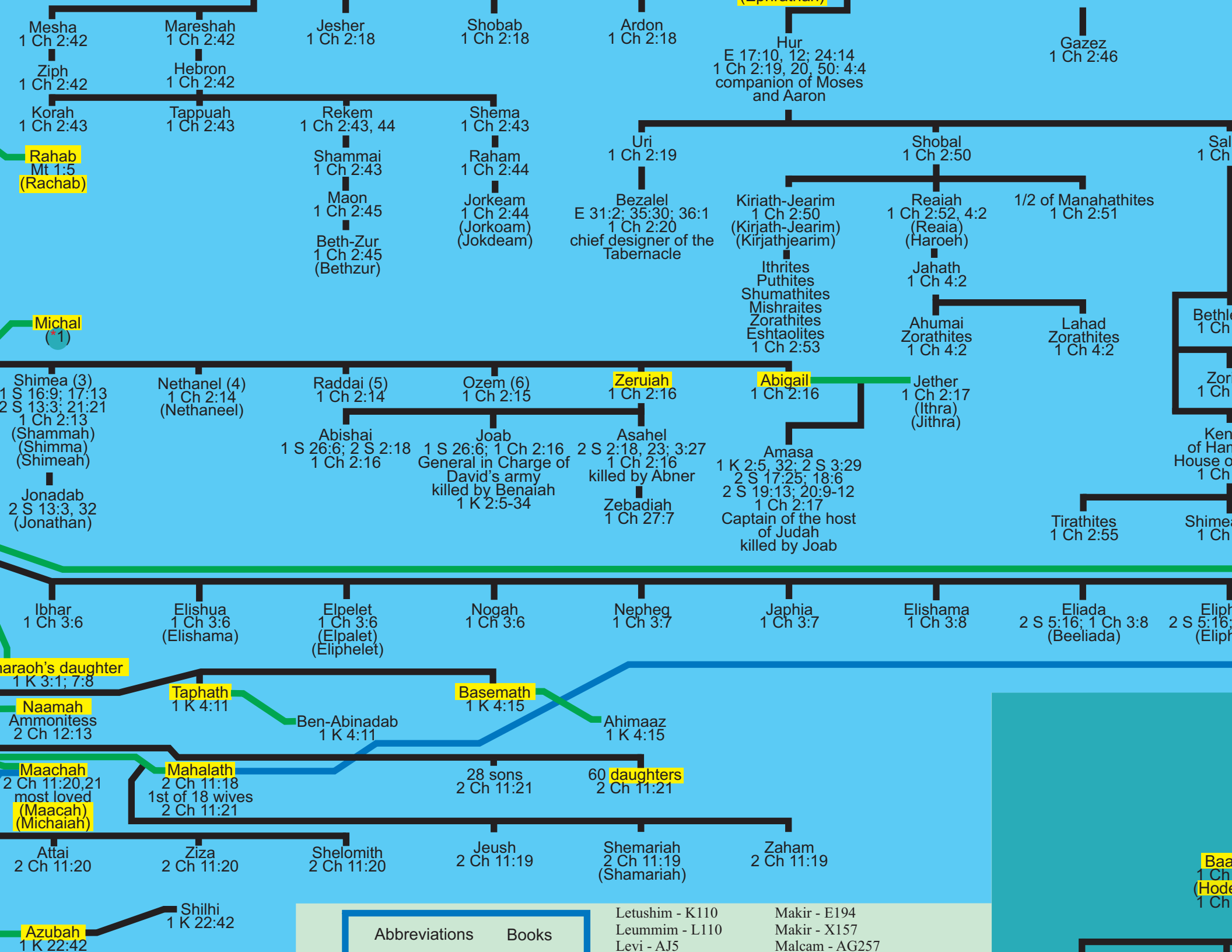

Meshah 1 Ch 2:42  
 Mareshah 1 Ch 2:42  
 Jeshur 1 Ch 2:18  
 Shobab 1 Ch 2:18  
 Ardon 1 Ch 2:18  
 Hur E 17:10, 12; 24:14  
 1 Ch 2:19, 20, 50: 4:4  
 companion of Moses  
 and Aaron  
 Gazez 1 Ch 2:46

Ziph 1 Ch 2:42  
 Hebron 1 Ch 2:42  
 Korah 1 Ch 2:43  
 Tappuah 1 Ch 2:43  
 Rekem 1 Ch 2:43, 44  
 Shema 1 Ch 2:43  
 Rahab Mt 1:5  
 (Rachab)

Shammai 1 Ch 2:43  
 Maon 1 Ch 2:45  
 Beth-Zur 1 Ch 2:45  
 (Bethzur)  
 Raham 1 Ch 2:44  
 Jorkeam 1 Ch 2:44  
 (Jorkoam)  
 (Jokdeam)  
 Bezalel E 31:2; 35:30; 36:1  
 1 Ch 2:20  
 chief designer of the  
 Tabernacle  
 Kiriath-Jearim 1 Ch 2:50  
 (Kirjath-Jearim)  
 (Kirjathjearim)  
 Ithrites  
 Puthites  
 Shumathites  
 Mishraites  
 Zorathites  
 Eshtaolites  
 1 Ch 2:53  
 Reaiah 1 Ch 2:52, 4:2  
 (Reaia)  
 (Haroeh)  
 1/2 of Manahathites  
 1 Ch 2:51  
 Jahath 1 Ch 4:2  
 Ahumai Zorathites  
 1 Ch 4:2  
 Lahad Zorathites  
 1 Ch 4:2

Michal 1  
 Shimea (3)  
 1 S 16:9; 17:13  
 2 S 13:3; 21:21  
 1 Ch 2:13  
 (Shammah)  
 (Shimma)  
 (Shimeah)  
 Jonadab 2 S 13:3, 32  
 (Jonathan)  
 Nethanel (4)  
 1 Ch 2:14  
 (Nethaneel)  
 Raddai (5)  
 1 Ch 2:14  
 Ozem (6)  
 1 Ch 2:15  
 Zeruiah 1 Ch 2:16  
 Abigail 1 Ch 2:16  
 Jether 1 Ch 2:17  
 (Ithra)  
 (Jithra)

Abishai 1 S 26:6; 2 S 2:18  
 1 Ch 2:16  
 Joab 1 S 26:6; 1 Ch 2:16  
 General in Charge of  
 David's army  
 killed by Benaiah  
 1 K 2:5-34  
 Asahel 2 S 2:18, 23; 3:27  
 1 Ch 2:16  
 killed by Abner  
 Zebadiah 1 Ch 27:7  
 Amasa 1 K 2:5, 32; 2 S 3:29  
 2 S 17:25; 18:6  
 2 S 19:13; 20:9-12  
 1 Ch 2:17  
 Captain of the host  
 of Judah  
 killed by Joab  
 Tirathites 1 Ch 2:55  
 Shimea 1 Ch 2:55

Ibhar 1 Ch 3:6  
 Elishua 1 Ch 3:6  
 (Elishama)  
 Elpelet 1 Ch 3:6  
 (Elpalet)  
 (Eliphelet)  
 Nogah 1 Ch 3:6  
 Nepheg 1 Ch 3:7  
 Japhia 1 Ch 3:7  
 Elishama 1 Ch 3:8  
 Eliada 2 S 5:16; 1 Ch 3:8  
 (Beeliada)  
 Eliaph 2 S 5:16; 1 Ch 3:8  
 (Eliaph)

Naamah Ammonitess 2 Ch 12:13  
 Taphath 1 K 4:11  
 Basemath 1 K 4:15  
 Ahimaaz 1 K 4:15  
 Ben-Abinadab 1 K 4:11

Maachah 2 Ch 11:20, 21  
 most loved  
 (Maacah)  
 (Michaiah)  
 Mahalath 2 Ch 11:18  
 1st of 18 wives  
 2 Ch 11:21  
 28 sons 2 Ch 11:21  
 60 daughters 2 Ch 11:21

Attai 2 Ch 11:20  
 Ziza 2 Ch 11:20  
 Shelomith 2 Ch 11:20  
 Jeush 2 Ch 11:19  
 Shemariah 2 Ch 11:19  
 (Shamariah)  
 Zaham 2 Ch 11:19

Shilhi 1 K 22:42  
 Azubah 1 K 22:42

Abbreviations	Books
Letushim - K110	Makir - E194
Leummim - L110	Makir - X157
Levi - AJ5	Malcam - AG257

Baa  
 1 Ch  
 (Hode)  
 1 Ch



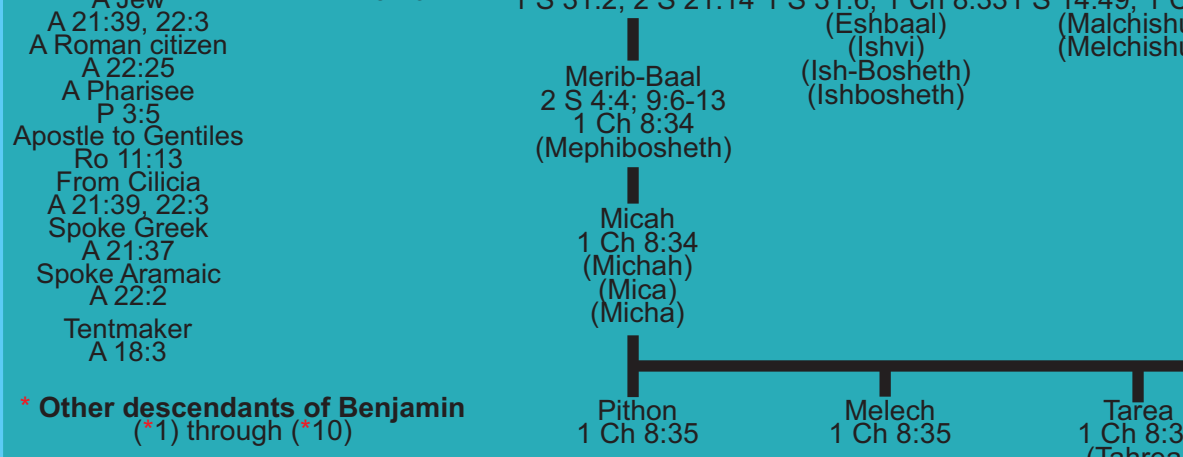
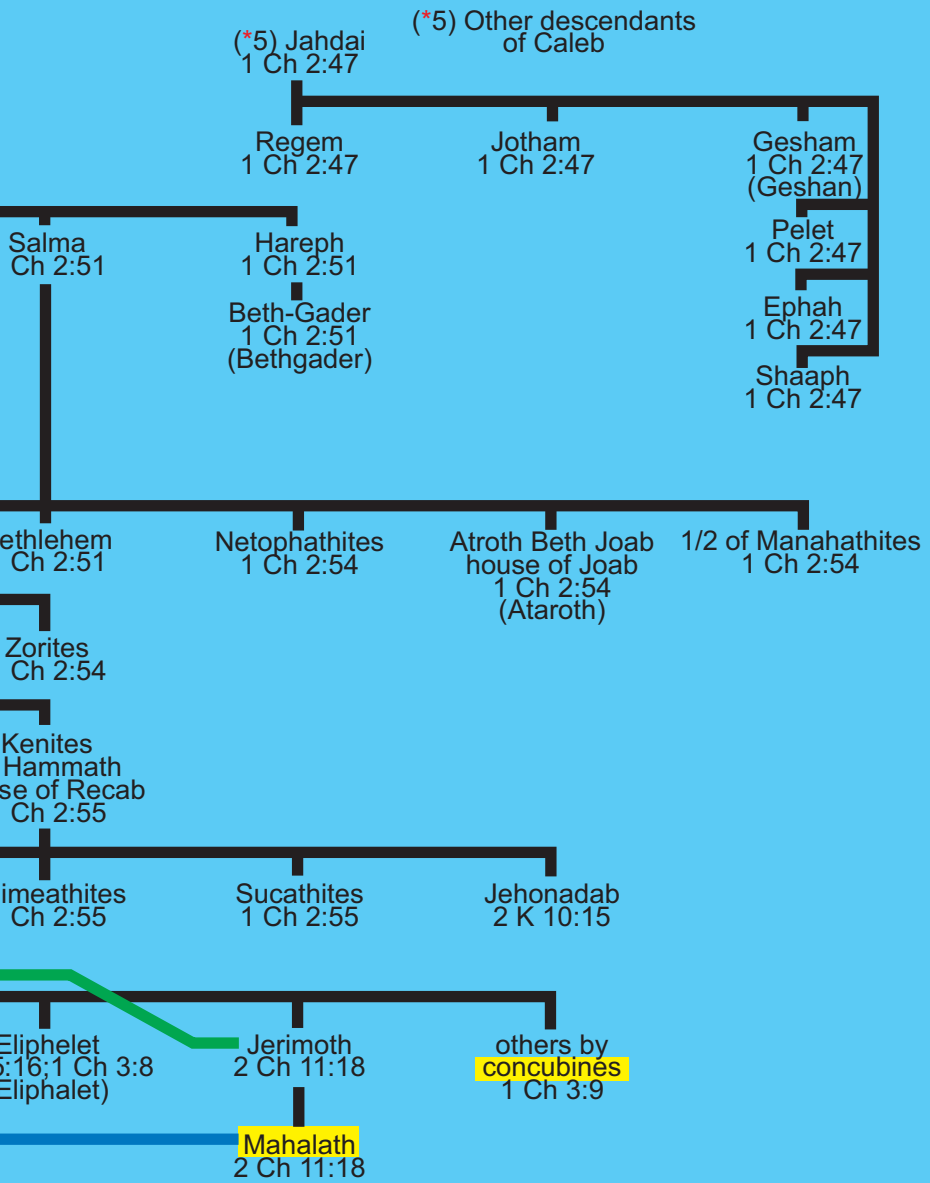

Benjamin is the most difficult tribe to chart a line of descent. There are no less than three locations in the Bible giving the sons of Benjamin: Genesis 46:21 - Benjamin had 10 sons, 1 Ch 7:6 - Benjamin had 3 sons, and 1 Ch 8:1-2 - Benjamin had 5 sons. Hebrew traditions may name a son, a grandson, or other important male members of the family as a son. Along with this there are 2 locations for the genealogy of Saul: 1 Ch 8:1-39 and 1 Ch 9:35-44.

Within all these verses and others it appears that Benjamin may have had 6 sons. Look at the following:

- (1) Beker - same as Becher
- (2) Ashbel
- (3) Rosh
- (4) Rapha
- (5) Jediael
- (6) Nohah

See the continuation to the right

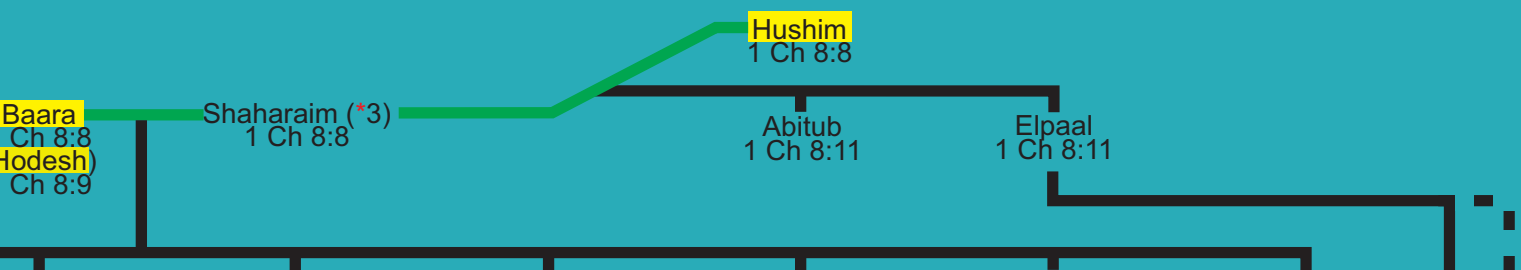
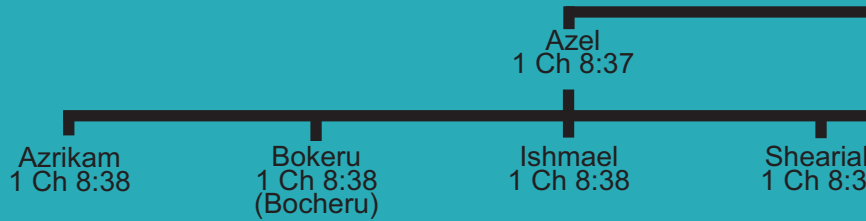
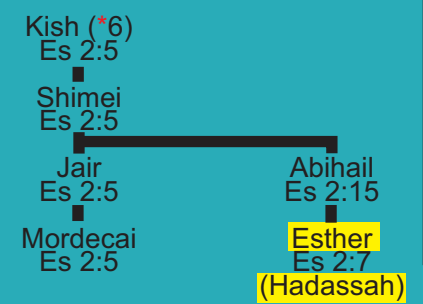

Ozem - O187	Ram - L187	Sarah - L187
Ozem - Z216	Ram - V183	Sarah - V183
Ozias - V290	Rapha - AN229	Sarah - AN229
Ozni - D52	Rapha - AR127	Saul - AR127
	Raphah - AN226	Saul - AN226
	Reaia - AC205	Seba - AC205
	Reaiah - AC203	Segub - AC203
	Reaiah - F22	Seir - F22
Pallu - C7	Rebecca - AB116	Selub - AB116
Palti - AR192		

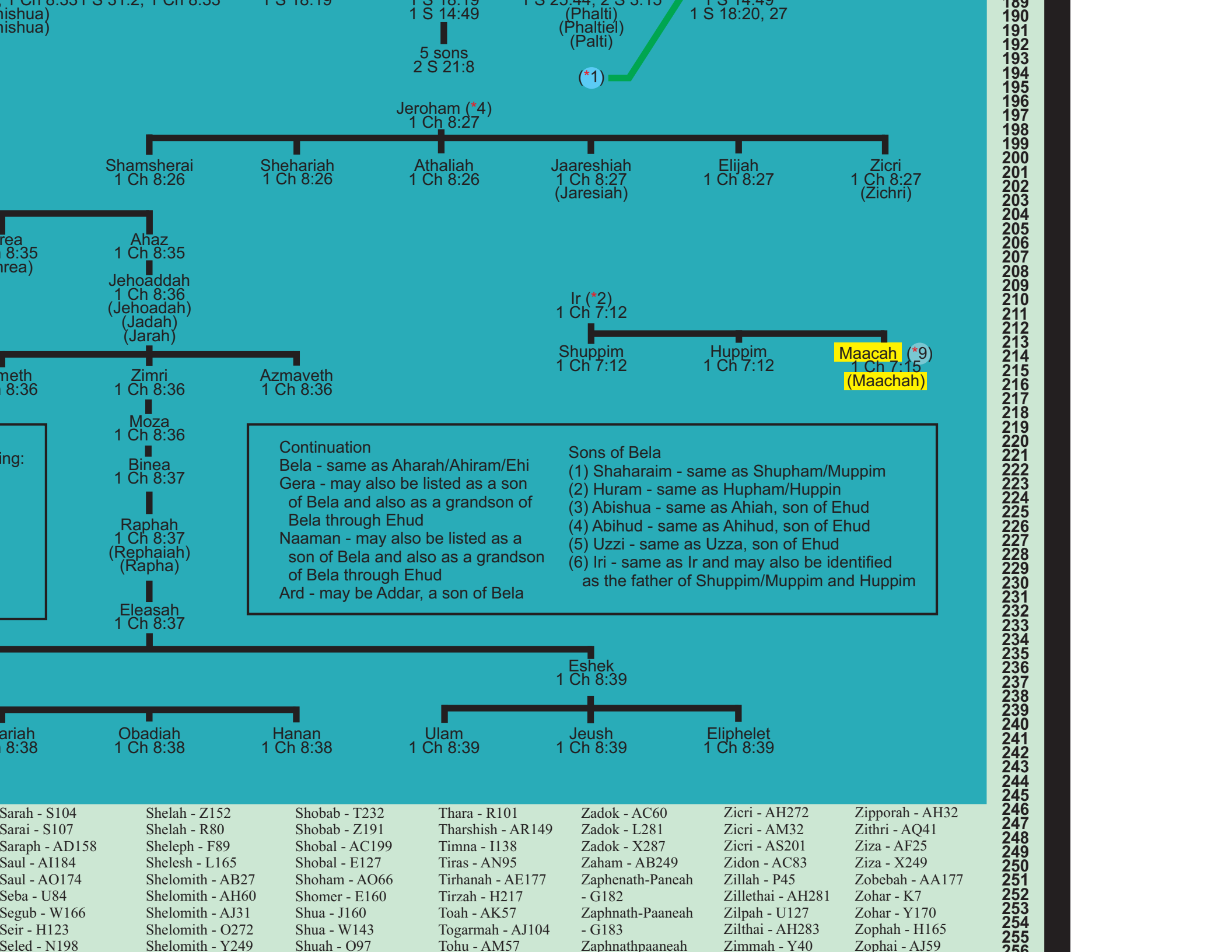



254	Abijah - AK70	Akan - M139	Assir - AJ39	Bethgader - AF205	Eder - AI268	Enoch - N30	Hagar - Q108
255	Abijah - AQ156	Akim - L286	Assir - AJ50	Bethlehem - AE211	Eder - AR52	Enoch - R50	Haggi - B50
256	Abijah - V249	Akkub - Q296	Assir - AK47	Bethuel - AC110	Edom - R131	Enos - R32	Haggiah - A
257	Abijah - V249	Akkub - Q296	Assir - AK47	Bethuel - AC110	Edom - R131	Enos - R32	Haggith - P
258	Abijah - W163	Alameth - AS156	Assir - M261	Beth Zur - Y206	Eglah - R229	Enosh - R28	Haggith - P
259	Abijah - W297	Alemeth - AM215	Atarah - Q183	Bethzur - Y208	Ehi - AS140	Ephah - AD183	Ham - Z72
260	Abijam - V252	Alemeth - AS154	Ataroth - AG214	Bezalel - AA203	Ehud - AQ135	Ephah - AH202	Hammoleke
261	Abimael - M89	Alian - C136	Athaliah - AP201	Bezer - F169	Eker - N191	Ephah - L103	Hammuel -
262	Abinadab - AN188	Almodad - E89	Athaliah - W265	Bilhah - U133	Eladah - I206	Epher - M103	Hamran - J
263	Abinadab - U216	Alvan - C134	Atroth Beth Joab -	Bilhan - AP132	Elah - AH169	Ephlal - Q216	Hamuel - L
264	Abinadab - U216	Alvan - C134	AG211	Bilhan - K139	Elam - AE276	Ephraim - J188	Hamul - U1
265	Abiram - D22	Amal - K165	Attai - Q213	Bimhal - B165	Elam - P76	Ephratah - AB187	Hamutal - N
266	Abishai - Y220	Amalek - I143	Attai - W249	Binea - AN222	Eldaah - P103	Ephrath - AB185	Hanan - AD
267	Abishalom - N237	Amariah - AC51	Azariah - AC55	Birzaith - K160	Elead - J214	Ephrathah - AB188	Hanan - AO
268	Abishua - AC45	Amariah - AC58	Azariah - AC57	Boaz - V203	Eleadah - I205	Er - U281	Hanani - AH
269	Abishua - AN142	Amasa - AB221	Azariah - AC63	Bocheru - AK243	Eleasah - AN232	Er - X152	Hananiah -
270	Abishur - P194	Amasai - AI57	Azariah - AK50	Bokeru - AK241	Eleasah - Q221	Er - Z158	Hananiah -
271	Abital - Q229	Amasai - AK53	Azariah - Q219	Booz - V205	Eleazar - AC39	Eran - I198	Hananiah -
272	Abitub - AH250	Amaziah - AR61	Azariah - R163	Bukki - AC47	Eleazar - AO52	Eri - E50	Haniel - G1
273	Abitub - AH250	Amaziah - AR61	Azariah - R163	Bukki - AC47	Eleazar - AO52	Eri - E50	Haniel - G1
274	Abiud - L272	Amaziah - V284	Azariah - V289	Bukkiah - AE66	Eleazar - L293	Esau - R128	Hannah - A
275	Abner - AS174	Aminadab - V190	Azel - AL236	Bunah - M187	Eleazar - S220	Esh-Baal - AL188	Hanniel - G
276	Abner - AS174	Aminadab - V190	Azmaveth - AO215	Buz - W110	Eliab - AJ62	Eshbaal - AL190	Hanoch - B
277	Abraham - R104	Ammiel - AH21	Azor - L278		Eliab - C16	Eshban - K134	Hanoch - N
278	Abram - R109	Ammiel - U224	Azrikam - AJ241		Eliab - R216	Eshek - AQ236	Haran - AD
279	Absalom - N234	Ammihud - K208	Azrikam - S292		Eliada - AD232	Esl - K274	Haran - AD
280	Achan - Q170	Amminadab - AK21	Azubah - W255		Eliakim - L252	Esrom - V165	Haran - AE
281	Achar - Q167	Amminadab - V187	Azubah - X185		Eliakim - L275	Esther - AJ231	Haran - X10
282	Achaz - V299	Amnon - L234			Eliakim - L275	Etam - M207	Hareph - AF
283	Achim - L288	Amon - V310			Eliakim - U248	Ethan - AR68	Harnepher -
284	Achsa - AG180	Amos - K281			Eliam - U226	Ethan - R159	Haroeh - AC
285	Achsa - AG180	Amon - V310			Eliashib - O296	Ethan - Y41	Harum - AB
286	Achsah - AG179	Amram - AI19			Eliathah - AD57	Ethnan - Z170	Haruz - X30
287	Achsah - AI171	Amram - J136			Eliel - AF272	Ethni - Y44	Hasadiah - S
288	Achsah - AI171	Amram - J136			Eliel - AI280	Eve - P17	Hashabiah -
289	Acsah - AG177	Amram - J136			Eliel - AK58	Ezbon - AL131	Hashabiah -
290	Acsah - AI169	Amzi - AR59			Elienai - AG280	Ezbon - D50	Hashubah -
291	Adah - L45	Anah - I130			Eliezer - AH39	Ezekias - V304	Hathath - A
292	Adah - N129	Anah - J127			Eliezer - AM154	Ezer - J206	Hattush - O
293	Adaiah - AJ280	Anah - Q138			Eliezer - U274	Ezer - L127	Havilah - P
294	Adaiah - X308	Anamim - W92			Elihu - AE52	Ezra - AD70	Havilah - V
295	Adaiah - Y42	Anani - T296			Elihu - AM58		Hazarmavet
296	Adam - R17	Anathoth - AR154			Elihu - S216		Hazeleponi
297	Adam - R17	Anathoth - AR154			Elijah - AR201		Haziel - AC
298	Adbeel - G119	Aniam - G212			Elimelech - T198	Gad - D44	Hazo - Z110
299	Addar - AN134	Aphiah - AQ154			Elioenai - AN154	Gad - V132	Hazzelepor
300	Addi - U292	Appaim - O198			Elioenai - Q292	Gaham - U115	Hazzobebah
301	Adonijah - P234	Ara - K176			Eliphalet - AE234	Gatam - L148	Heber - AG
302	Adonijah - P234	Arad - AH268			Eliphaz - N143	Gazez - AD192	Heber - D15
303	Adriel - AO188	Arah - F150			Eliphelet - AE235	Gazez - AF187	Hebron - A
304	Agar - Q107	Aram - G165			Eliphelet - AR241	Ge Harashim - AL176	Hebron - X
305	Aharah - AS143	Aram - T76			Eliphelet - Y232	Gedaliah - AD13	Helah - Z16
306	Aharhel - AB178	Aram - V185			Elishah - AK104	Gedor - AM159	Helek - D20
307	Ahaz - AN206	Aran - X114			Elishama - AC232	Gera - AL142	Helem - H1
308	Ahaz - V297	Ard - AR143					
309	Ahaziah - V269						
310	Ahaziah - V269						
311	Ahban - P198						
312	Ahi - D165						
313	Ahiah - AP142						
314	Ahian - D212						
315							

## A

## B

## C

## D

## E

## F

Homam - G130	Jaasiah - AS181	Jemuel - G7	Joel - AJ70
B50	Hori - F130	Jephthae - B208	Joel - AK51
h - AN55	Hoshama - Q261	Jephthah - B206	Joel - C89
h - P229	Hoshea - K217	Jephunneh - AJ163	Joel - F8
Z72	Hotham - H160	Jephunneh - I176	Joha - AJ272
oleketh - B199	Hothir - AF62	Jacob - S128	Johanah - AC56
uel - L13	Hubbah - F165	Jada - R191	Johanah - M251
n - J137	Hul - U79	Jadah - AN211	Johanah - R296
l - L14	Huppim - AR214	Jahath - AC208	Jokdeam - Z206
- U164	Huppim - AS130	Jahath - AE25	Jokim - AB158
al - N247	Hur - AB192	Jahath - AJ35	Jokshan - K97
- AD276	Huram - AL148	Jahath - Y38	Joktan - Q86
- AO241	Hushim - A21	Jahaziel - AF32	Jonadab - W224
- AH70	Hushim - AH246	Jahzai - AP191	Jonam - U251
ah - AE276	Huz - V112	Jahleel - C106	Jonan - U253
ah - AG70		Jahmai - D78	Jonathan - AJ188
ah - N272	<b>I</b>	Jahmeel - D78	Jonathan - S194
- G152		Jahzeel - A37	Jonathan - W226
a - AL60	Ibhar - W232	Jahziel - A35	Joram - AH52
l - G150	Ibri - AQ66	Jair - AI228	Joram - V267
n - B7	Ibsam - E78	Jair - W170	Jorim - U271
n - N103	Idbash - N211	Jakan - M141	Jorkeam - Z203
- AD187	Iddo - Z41	Jakim - AD280	Jorkeam - Z205
- AD25	Iezer - C206	Jakin - J7	Jorkeam - Z205
- AE105	Igal - P289	Jakim - J7	Jorkeam - Z205
- X101	Imna - I165	Jakin - J7	Jorkeam - Z205
- AF199	Imnah - A145	Jakin - J7	Jorkeam - Z205
her - B169	Imrah - E169	Jakin - J7	Jorkeam - Z205
- AC206	Iphdeiah - Ah276	Jakin - J7	Jorkeam - Z205
- AB175	Iphedeiah - AH278	Jakin - J7	Jorkeam - Z205
- X304	Ir - AM136	Jakin - J7	Jorkeam - Z205
ah - S272	Ir - AQ210	Jakin - J7	Jorkeam - Z205
iah - AE17	Irad - N33	Jakin - J7	Jorkeam - Z205
iah - AR63	Iri - AM134	Jakin - J7	Jorkeam - Z205
ah - P272	Iru - AG169	Jakin - J7	Jorkeam - Z205
n - AJ173	Isaac - S114	Jakin - J7	Jorkeam - Z205
n - O289	Isciah - X105	Jakin - J7	Jorkeam - Z205
n - P89	Ishbak - N97	Jakin - J7	Jorkeam - Z205
n - V84	Ish-Bosheth - AL192	Jakin - J7	Jorkeam - Z205
aveth - G89	Ishbosheth - AL193	Jakin - J7	Jorkeam - Z205
lponi - O213	Ishhod - A220	Jakin - J7	Jorkeam - Z205
- AC25	Ishi - Q202	Jakin - J7	Jorkeam - Z205
- Z110	Ishiah - D91	Jakin - J7	Jorkeam - Z205
elponi - O211	Ishma - M211	Jakin - J7	Jorkeam - Z205
ebah - AA175	Ishmael - AL241	Jakin - J7	Jorkeam - Z205
- AG289	Ishmael - Q114	Jakin - J7	Jorkeam - Z205
- D154	Ishmerai - AH289	Jakin - J7	Jorkeam - Z205
- AO19	Ishpah - AI272	Jakin - J7	Jorkeam - Z205
- X194	Ishpan - AD272	Jakin - J7	Jorkeam - Z205
- Z166	Ishuah - B149	Jakin - J7	Jorkeam - Z205
- D206	Ishuai - C149	Jakin - J7	Jorkeam - Z205
- H162	Ishvah - B145	Jakin - J7	Jorkeam - Z205
		Jakin - J7	Jorkeam - Z205

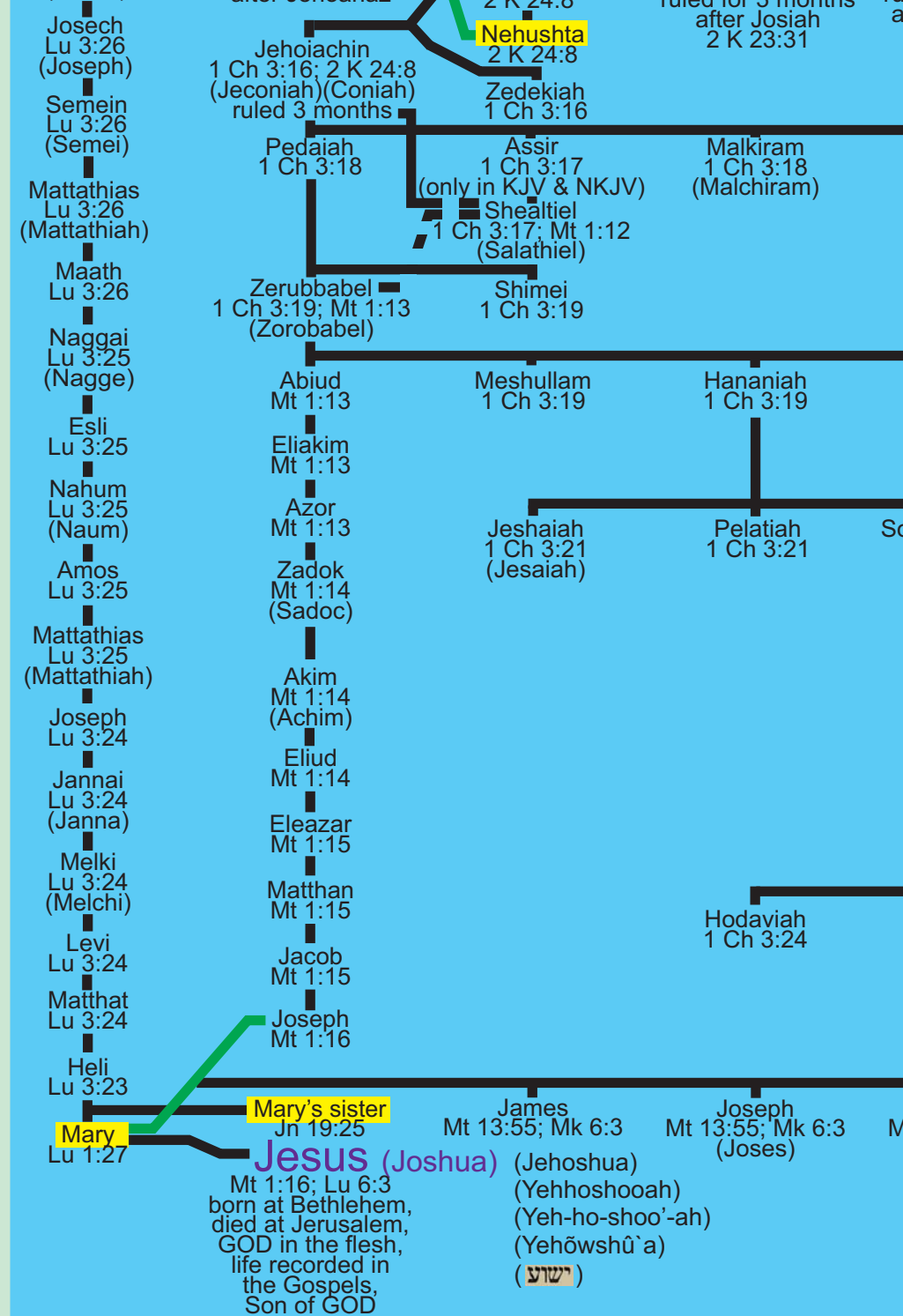

**G H I J K L M N**

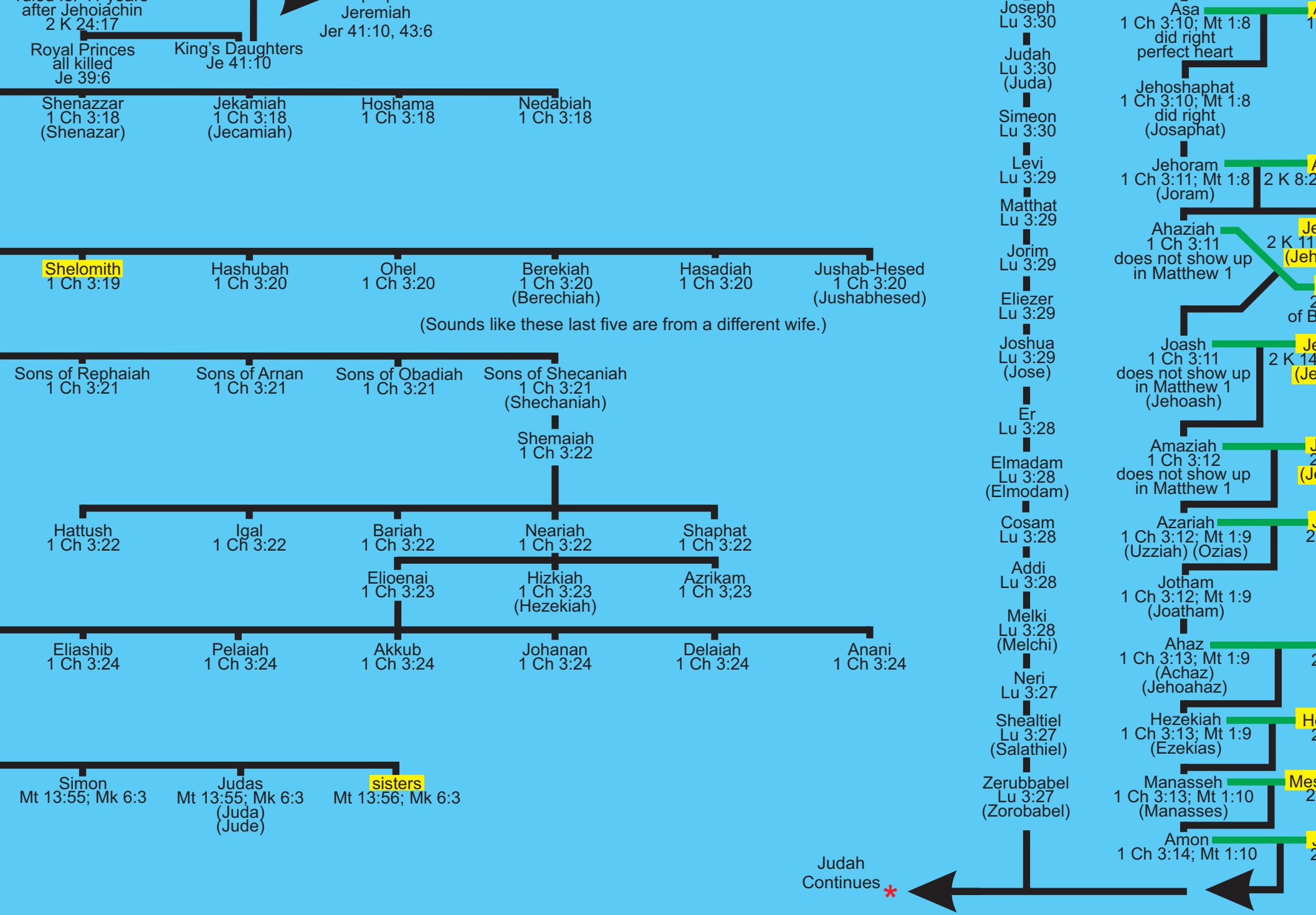

O P Q R S T U V

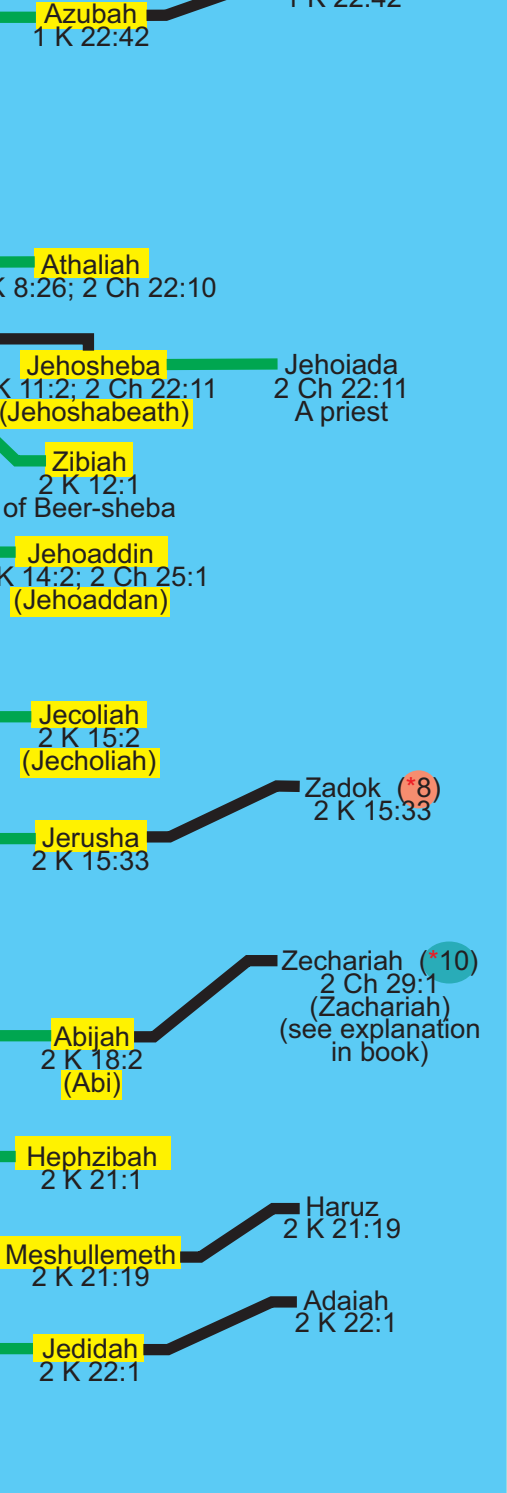

Abbreviations	Books
A	Acts
Ch	Chronicles
E	Exodus
Es	Esther
Ez	Ezra
G	Genesis
Je	Jeremiah
Jo	Joshua
Ju	Judges
K	Kings
Lu	Luke
Mk	Mark
Mt	Matthew
N	Numbers
P	Philippians
R	Ruth
Rev	Revelation
Ro	Romans
S	Samuel

Judas - P306	Kish - AO169
Judas - V148	Kish - AP52
Jude - P309	Kishi - AR66
Judith - P128	Kittim - AM104
Jushab-Hesed - T272	Kothath - AK9
Jushabhesed - T274	Korah - AK32
	Korah - N148
	Korah - Q146
	Korah - W197
	Koz - AA170
	Kushaiah - AR67
Kedar - F119	
Kedemah - P119	
Kemuel - X110	
Kenaanah - AR135	
Kenan - R33	
Kenaz - AH172	Laadah - AA158
Kenaz - AK166	Laadan - AA22
Kenaz - M148	Laadan - K207
Keran - M134	Laban - AC114
Kesed - Y110	Ladan - AA21
Keturah - P93	Ladan - K206
Kileab - M237	Lahad - AD212
Kilion - S203	Laish - AQ183
Kiriath-Jearim - AB203	Lamech - N45
Kirjath-Jearim - AB205	Lamech - R62
Kirjathjearim - AB206	Leah - Y121
Kish - AI159	Lecah - Z161
Kish - AI223	Lehabim - X92

Leummim - L110	M
Levi - AJ5	Maacah - AD172
Levi - K298	Maacah - AI152
Levi - U265	Maacah - AS214
Levi - X126	Maacah - F194
Libni - AA19	Maacah - N229
Libni - AN51	Maacah - O241
Likhi - F212	Maacah - W105
Lot - AE110	Maacah - W245
Lotan - G127	Maachah - AD175
Lud - S76	Maachah - AI154
Ludim - V92	Maachah - AS216
	Maachah - F196
	Maachah - N232
	Maachah - O240
	Maachah - W107
	Maachah - W243
	Maath - K267
	Maaz - L191
	Macbenah - AG188
	Machbenah - AG186
	Machir - E196
	Madai - AJ95
	Madmannah - AF181
	Magog - AI95
	Mahalaleel - R42
	Mahalalel - R38
	Mahalath - AF236
	Mahalath - D119
	Mahalath - X243
	Mahali - AP46
	Mahath - AK54
	Mahazioth - AG62
	Mahlah - C220
	Mahlah - D217
	Mahli - AP43
	Mahli - AQ52
	Mahlon - T203
	Malkam - AG257
	Malcham - AG259
	Malchiah - Y48
	Malchiel - K156
	Malchijah - Y47
	Malchiram - N263
	Malchishua - AM190
	Maleleel - R41
	Malki-Shua - AM188
	Malkiel - K154
	Malkijah - Y46
	Malkiram - N261
	Mallothi - AE62
	Malluch - AR64
	Manahath - D134
	Manasseh - E188
	Manasseh - V306
	Manasses - V308
	Maon - Y203
	Mara - U200
	Mareshah - AA161
	Mareshah - X191
	Mary - K307
	Mash - W81
	Massa - K119
	Mathusala - R60
	Mattaniah - AF66
	Mattaniah - O252
	Mattatha - U236
	Mattathah - U238
	Mattathiah - K265
	Mattathiah - K286
	Mattathias - K263
	Mattathias - K284
	Matthan - L296
	Matthat - K301
	Matthat - U268
	Mattithiah - AF17
	Medan - L97
	Mehujael - N37
	Melchi - K296
	Melchi - U297
	Melchishua - AM191
	Melea - U244
	Melech - AL206
	Melki - K294
	Melki - U295
	Menan - U242
	Menna - U240
	Meonothai - AK173
	Mephibosheth - AK195

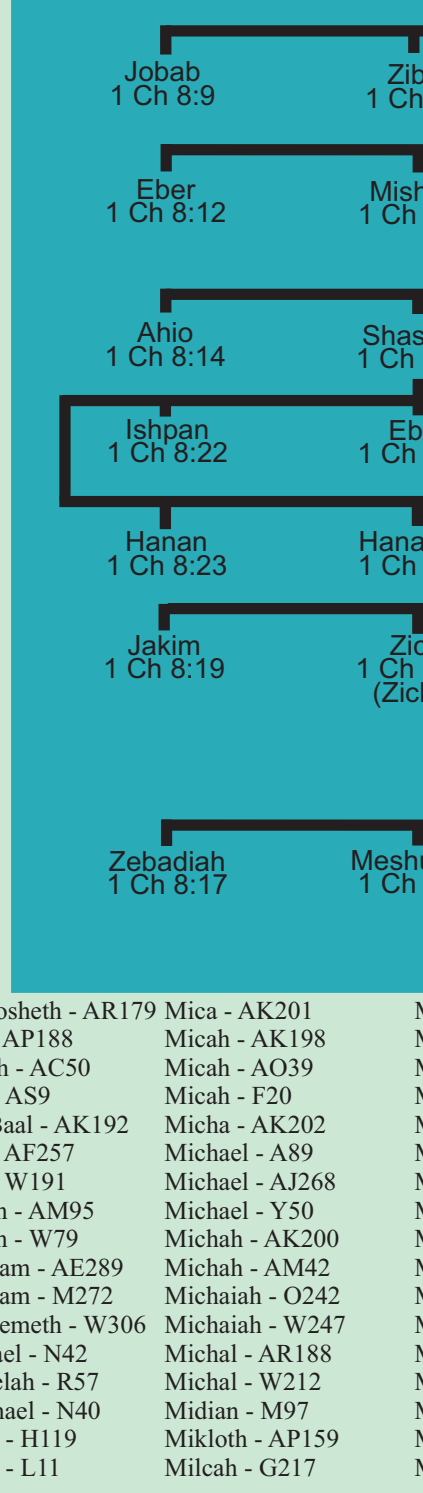



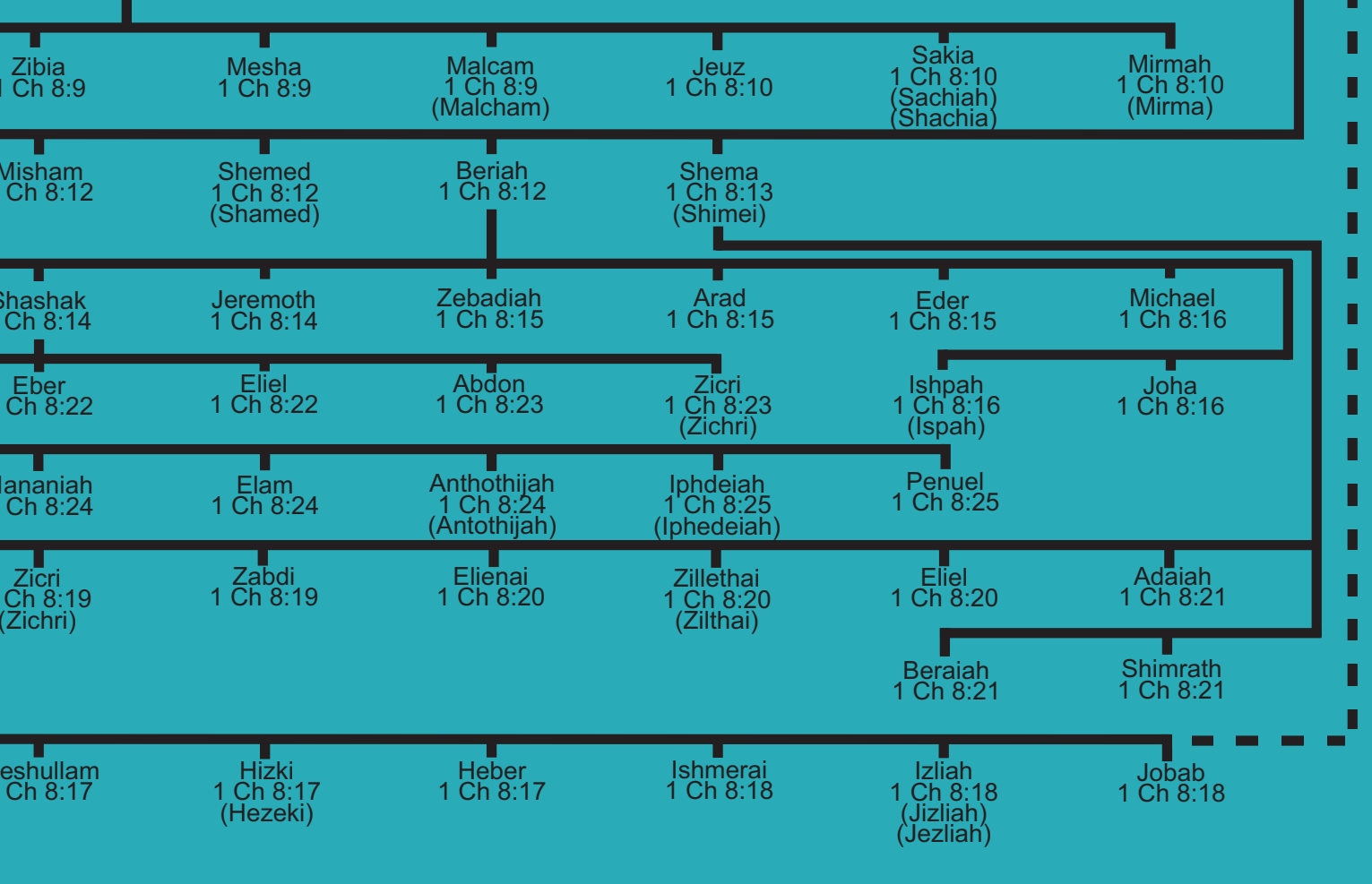

- Pallu - C7
- Paltiel - AR188
- Pathrus - A165
- Patrasim - Z92
- Paul - AI186
- Pedaiah - L261
- Pedaiah - N244
- Pelaiah - P297
- Pelathiah - N279
- Peleg - R86
- Pelet - AH198
- Peleth - R198
- Peninnah - AL53
- Penuel - AI276
- Peresh - F199
- Perez - V152
- Peullethai - AG17
- Peulthai - AG19
- Phallu - C9
- Phalti - AR190
- Phaltiel - AR191
- Phares - V156
- Pharez - V157
- Philistim - AA95
- Philistines - AA99
- Phinehas - AC42
- Phut - AB79
- Phuvah - B72
- Pildash - AA110
- Pispah - J176
- Pithon - AK206
- Potiphera - H174
- Poti-Pherah - H177
- Potipherah - H178
- Pua - B70
- Puah - B68
- Put - AB77
- Putiel - AD39
- Puvah - B71
- R**
- Raama - X86
- Raamah - X84
- Rachab - W202
- Rachel - AC121
- Raddai - Y216
- Raguel - AJ27
- Rahab - W200
- Raham - Z200
- Rakem - G190
- Reaiah - F22
- Rebecca - AB116
- Rebekah - AB114
- Regem - AF195
- Rehabiah - AH45
- Rehoboam - V240
- Rekem - Y197
- Rephael - AE48
- Rephah - K200
- Rephaiah - AN228
- Rephaiah - B78
- Rephaiah - O279
- Resheph - K203
- Reu - R89
- Reuben - C3
- Reuben - V126
- Reuel - AJ22
- Reuel - D125
- Reumah - U105
- Rezia - H152
- Rhesa - K244
- Riphath - AI104
- Rizia - H150
- Rizpah - AQ174
- Roboam - V243
- Rodanim - AN104
- Rohgah - E165
- Romamti-Ezer - AF57
- Romamtiezer - AF59
- Rosh - AQ130
- Ruth - U203
- S**
- Sabta - W86
- Sabtah - W84
- Sabteca - Y84
- Sabtechah - Y86
- Sabtechah - Y87
- Sacar - AF21
- Sachiah - AI258
- Sadoc - L283
- Sakia - AI256
- Salah - R82
- Salathiel - M266
- Salathiel - U304
- Salma - AE199
- Salma - V200
- Salmon - V198
- Samuel - AJ67
- Samuel - AK65
- Samuel - F78
- Seleah - F22
- Semaiah - AB114
- Semai - AF195
- Semai - AH45
- Seraiah - V240
- Seraiah - Y197
- Seraiah - AE48
- Sereah - K200
- Seruiah - AN228
- Sethiah - B78
- Shaah - O279
- Shaah - K203
- Shachar - R89
- Shahar - C3
- Shallu - V126
- Shallu - AJ22
- Shallu - D125
- Shallu - U105
- Shallu - H152
- Shamshai - K244
- Shamshai - AI104
- Shamshai - H150
- Shamshai - AQ174
- Shamshai - V243
- Shamshai - AN104
- Shamshai - E165
- Shamshai - AF57
- Shamshai - AF59
- Shamshai - AQ130
- Shamshai - U203
- Shaphan - H174
- Shaphan - H177
- Shaphan - H178
- Shaphan - W86
- Shaphan - W84
- Shaphan - Y84
- Shaphan - Y86
- Shaphan - Y87
- Shaphan - AF21
- Shaphan - AI258
- Shaphan - L283
- Shaphan - AI256
- Shaphan - R82
- Shaphan - M266
- Shaphan - U304
- Shaphan - AE199
- Shaphan - V200
- Shaphan - V198
- Shaphan - AJ67
- Shaphan - AK65
- Shaphan - F78

- Milcah - W105
- Miriam - Z32
- Mirra - AJ259
- Mirmah - AJ257
- Mishael - AO43
- Misham - AE262
- Mishma - I119
- Mishma - L12
- Mizraim - AA77
- Mizzah - D130
- Moab - AE120
- Molid - Q198
- Mordecai - AI231
- Moses - AG32
- Moza - AE187
- Moza - AN218
- Muppim - AR130
- Mushi - AR43
- N**
- Naam - AG172
- Naamah - P52
- Naamah - W239
- Naaman - AL138
- Naaman - AO140
- Naaman - AR140
- Naarah - AD164
- Naasson - V196
- Nabal - L225
- Nachor - V107
- Nadab - AA39
- Nadab - AL159
- Nadab - O194
- Naggai - K270
- Nagge - K272
- Nahash - U212
- Nahath - A130
- Nahath - AJ61
- Nahor - R95
- Nahor - V105
- Nahshon - V193
- Nahum - K277
- Naomi - U198
- Naphish - O119
- Naphtali - C28
- Naphtali - W138
- Naphtuhim - Y92
- Nathan - Q214
- Nathan - U232
- Naum - K279
- Neariah - R289
- Nebaioth - E119
- Nebajoth - E121
- Nedabiah - R261
- Nehushta - M255
- Nemuel - B22
- Nemuel - G9
- Nepheg - AA232
- Nepheg - AL32
- Nephtalim - C29
- Ner - AK159
- Ner - AS169
- Neri - U299
- Nethanel - AG21
- Nethanel - X216
- Nethaniah - AA60
- Nimrod - Z84
- Noah - E217
- Noah - R66
- Noe - R70
- Nogah - Z232
- Nohah - AQ127
- Nun - K211
- O**
- Obadiah - AN241
- Obadiah - B89
- Obadiah - Q279
- Obal - L89
- Obed - AF48
- Obed - Q217
- Obed - V208
- Obed-Edom - AC17
- Obededom - AC19
- Ohad - I7
- Ohel - Q272
- Oholibamah - K130
- Oholibamah - Q141
- Omar - M156
- Omri - AO154
- Onam - G134
- Onam - Q187
- Onan - Y152
- Ophir - O89
- Ophrah - AK176
- Oren - N187
- Orpah - R203
- Oshea - K218
- Othni - AD48
- Othniel - AJ170

**AE AF AG AH AI AJ AK AL A**

H123	Shelomith - O272	Shua - W143	Togamah - AJ104	- G183	Zilthai - AH283	Zophai - H165	254
Seled - N198	Shelomith - Y249	Shuah - O97	Tohu - AM57	Zaphnathpaaneah	Zimma - Y40	Zophai - AJ59	255
Semachiah - AF51	Shelomoth - AB25	Shual - C169	Tola - A68	- G184	Zimma - Z39	Zorobabel - L270	256
Semei - K261	Shelomoth - AJ34	Shubael - AG45	Tubal - AL95	Zara - U155	Zimran - J97	Zorobabel - U308	257
Semein - K259	Shem - R72	Shubael - AG57	Tubalcain - O56	Zarah - U154	Zimri - AN215	Zorobabel - U308	258
Serah - E148	Shema - AH262	Shuham - A23	Tubal-Cain - O52	Zaza - S198	Zimri - Q159	Zuph - AK56	259
Seraiah - AC65	Shema - Z197	Shuni - C50		Zebadiah - AA224	Zina - AF27	Zur - AH159	260
Seraiah - AL170	Shemaiah - AC21	Shupham - AN148	<b>U</b>	Zebadiah - AD289	Ziph - W194		261
Sered - A106	Shemaiah - F11	Shuppim - AN149		Zebadiah - AG268	Ziphion - A52	Last update 7/08/15	262
Serug - R92	Shemaiah - R283	Shuppim - AQ214	Ulam - AP241	Zebidah - M247			263
Seth - R23	Shemariah - AA249	Shuthelah - I195	Ulam - H190	Zebudah - M249			264
Shaaph - AF177	Shemed - AF262	Shuthelah - I210	Ulla - F145	Zebulun - AA126			265
Shaaph - AH204	Shemer - AR56	Sidon - AC81	Uri - AA199	Zebulun - B100			266
Shachia - AI259	Shemer - E162	Simeon - I3	Uriah - T228	Zechariah - AN47			267
Shaharaim - AF250	Shemida - G206	Simeon - U262	Urias - T230	Zechariah - AO163			268
Shallum - AC61	Shemidah - G208	Simeon - W126	Uriel - AJ52	Zechariah - X294			269
Shallum - E37	Shemuel - F80	Simon - O306	Uriel - R242	Zecher - AO161			270
Shallum - L10	Shenazar - O263	Sisamai - Q223	Uz - L130	Zedekiah - M258			271
Shallum - N250	Shenazzar - O261	Sismai - Q222	Uz - T79	Zedekiah - O251			272
Shallum - Q224	Shephathiah - Q234	Sithri - AQ39	Uz - V110	Zeker - AO159			273
Shamariah - AA251	Shephi - F136	Solomon - V232	Uzal - J89	Zelophehad - H212			274
Shamed - AF263	Shepho - F134	Suah - A169	Uzza - AP144	Zemira - AK156			275
Shamer - AR57	Shephupham - AN147		Uzzah - AN53	Zemirah - AK154			276
Shamer - E162	Shephuphan - AN145	<b>T</b>	Uzzah - T220	Zephaniah - AK49			277
Shamir - AO46	Sheresh - G199		Uzzi - A78	Zephi - N158			278
Shamma - H169	Sheshan - Q205	Tahan - J202	Uzzi - AC48	Zepho - N156			279
Shammah - C130	Sheth - R26	Tahan - K205	Uzzi - AM131	Zephon - A50			280
Shammah - W219	Sheva - AG181	Tahash - V115	Uzziah - AJ53	Zerah - B130			281
Shammai - P191	Shilhi - X253	Tahath - AJ51	Uzziah - V290	Zerah - K9			282
Shammai - Y200	Shillem - E35	Tahath - AK48	Uzziel - AG66	Zerah - U152			283
Shammua - S232	Shilshah - I169	Tahath - I204	Uzziel - AN131	Zerah - Y43			284
Shammuah - S234	Shimea - AN54	Tahath - I207	Uzziel - AR19	Zerah - Z42			285
Shamsherai - AN201	Shimea - S235	Tahrea - AM208		Zerahiah - AC49			286
Shaphat - S289	Shimea - W216	Talmai - N225	<b>V</b>	Zereth - X170			287
Shashak - AE268	Shimea - Y51	Tamar - N240		Zeri - AE13			288
Shaul - AJ54	Shimeah - AP162	Tamar - O234	Vashni - AJ72	Zeror - AQ162			289
Shaul - L7	Shimeah - W221	Tamar - W152		Zerubbabel - L268			290
Shealtiel - M264	Shimeam - AP164	Taphath - X238	<b>Z</b>	Zerubbabel - U306			291
Shealtiel - U302	Shimei - AB19	Tappuah - X197		Zeruiah - AA216			292
Sheariah - AM241	Shimei - AD17	Tarea - AM206	Zaavan - L139	Zetham - Z25			293
Sheba - J103	Shimei - AH264	Tarshish - AL104	Zabad - I209	Zethan - AS135			294
Sheba - N89	Shimei - AI226	Tarshish - AR147	Zabad - Q215	Zibeon - I127			295
Sheba - X88	Shimei - AN52	Tarshishah - AL106	Zabdi - AF280	Zibeon - Q133			296
Sheber - AD177	Shimei - F17	Tebah - T115	Zabdi - Q161	Zibia - AE257			297
Shebuel - AG47	Shimei - L17	Tekoa - AB170	Zabulon - AA129	Zibiah - W273			298
Shebuel - AG59	Shimei - M268	Telah - K204	Zacchur - L16	Zichri - AE282			299
Shecaniah - R279	Shimei - Y39	Tema - M119	Zaccur - AP66	Zichri - AH57			300
Shechaniah - R281	Shimi - AB21	Temani - AE170	Zaccur - L15	Zichri - AH274			301
Shechem - E212	Shimma - W220	Terah - R98	Zaccur - Y60	Zichri - AM34			302
Shechem - F206	Shimrath - AJ285	Thahash - V117	Zachariah - X296	Zichri - AS203			303
Sheerah - K190	Shimrom - D70	Thamar - W154	Zacher - AO162	Zicri - AE280			304
Shehariah - AO201	Shimron - D68		Zadok - AC53	Zicri - AH55			305

Adam & Eve Family Tree™  
 Copyright © 1994-2015  
 Rev. Charles E. Darnell, PhD  
 All Rights Reserved

In its large format this chart has its own ISBN 1-889949-01-9

In individual page format it is part of the book, *Lineage of the King of Kings* and under its ISBN 1-889949-11-6

In e-book file format this chart has the following ISBN 1-889949-26-4

✠ VQ C

Presented by:  
 VisionQuest Publishing, Inc.  
 Campbellsville, KY 42718  
<http://www.VQPub.Org>

**AM**

**AN**

**AO**

**AP**

**AQ**

**AR**

**AS**

254  
255  
256  
257  
258  
259  
260  
261  
262  
263  
264  
265  
266  
267  
268  
269  
270  
271  
272  
273  
274  
275  
276  
277  
278  
279  
280  
281  
282  
283  
284  
285  
286  
287  
288  
289  
290  
291  
292  
293  
294  
295  
296  
297  
298  
299  
300  
301  
302  
303  
304  
305  
306  
307  
308  
309  
310  
311  
312  
313  
314  
315